




# SUNSYNK-W10.6



## USER MANUAL

[www.sunsynk.com](http://www.sunsynk.com)  
[sales@sunsynk.com](mailto:sales@sunsynk.com)  
[customerservices@sunsynk.com](mailto:customerservices@sunsynk.com)

v.1 (26/07/24)

 **PLEASE RETAIN FOR  
FUTURE REFERENCE**

# Table of Contents

<b>INTRODUCTION</b>	<b>3</b>
<b>BATTERY EXPANSION AND USE</b>	<b>3</b>
<b>SAFETY</b>	<b>4</b>
Handling	6
Damaged Battery	6
<b>SPECIFICATIONS AND FUNCTIONS</b>	<b>6</b>
Dimensions and Weight	6
Basic System Architecture	7
<b>TECHNICAL DATA</b>	<b>8</b>
<b>EQUIPMENT INTERFACE INSTRUCTION</b>	<b>9</b>
<b>INSTALLATION</b>	<b>11</b>
Parts List	11
Installation Precaution	12
Selecting the Mounting Area	12
Tools and Safety Gears Necessary	13
Mounting the Battery	14
Wall-Mounted Method	14
Floor-Mounted Method	16
Batteries in Parallel	18
Parallel Mode 1 (Inverter Power $\leq 15\text{kW}$ )	18
Parallel Mode 2 (Inverter Power $> 15\text{kW}$ )	19
Electrical Schematic Diagram	20
Battery Connected to Inverter	20
Connection Inspection	22
Starting the SUNSYNK-W10.6 Battery	23
Wiring Diagram	25
Symbol Explanation	28
<b>MONITORING</b>	<b>29</b>
<b>INSPECTION, CLEANING AND MAINTENANCE</b>	<b>34</b>
General Information	34
Inspection	34
Cleaning	34
Maintenance	34
Storage	34
<b>TROUBLESHOOTING</b>	<b>35</b>
<b>BATTERY RECOVERY</b>	<b>36</b>
Recovery Process and Steps of Cathode Materials	36
Recovery of Anode Materials	36
Recovery of Diaphragm	36
List of Recycling Equipment	36
<b>TRANSPORTATION REQUIREMENTS</b>	<b>37</b>

# INTRODUCTION

---

Thank you for choosing Sunsynk's energy storage system.

SUNSYNK-W10.6 lithium iron phosphate battery is one of the new energy storage products developed and produced by SUNSYNK. SUNSYNK-W10.6 is especially suitable for application scenarios of high power, limited installation space, and long cycle life. It can be used to support reliable power for various types of equipment and systems.

The energy storage module includes lithium-ion rechargeable batteries with 10.64kWh capacity, and the controller enables a central of multiple modules. Thus, batteries can be connected in parallel to expand capacity and power for applications that require larger capacity and longer power support.

SUNSYNK-W10.6 has a built-in BMS (battery management system), which can manage and monitor cell-battery information, including voltage, current, and temperature. Moreover, the BMS can balance cells charging and discharging to extend cycle life.

This manual provides information regarding safety precautions to prevent possible accidents and how to use the product. Please read this manual carefully before use for safety and keep this manual handy for reference.

Some main features of this product are:

- Cobalt-free Lithium Iron Phosphate (LFP) Battery: Ensures safety, long lifespan, and high-energy density. Low voltage safety connection.
- Supports maximum 1C charge and 1.25C discharge rates. Offers up to 6000 cycles at 90% Depth of Discharge (DOD) and comes with a standard 10-year warranty.
- Battery Management System (BMS) includes protection functions against over-discharge, over-charge, over-current, and high & low temperatures.
- Built-in Intelligent BMS provides comprehensive protection. Features natural cooling, IP65 rating, and operates within a wide temperature range from -20°C to 55°C.
- Modular design facilitates easy expansion, supporting up to 32 units in parallel with a maximum capacity of 320kWh. Ideal for residential and commercial applications to enhance self-consumption ratios.
- Battery module auto-networking (No DIP switch code) enables easy maintenance and supports remote monitoring and upgrades via SUNSYNK platform. Compatible with SUNSYNK inverters for a stack all-in-one system.
- Uses environmentally friendly materials, ensuring the entire module is non-toxic and pollution-free. Flat design allows for wall mounting with a wall bracket or floor installation with a removable base, optimizing installation space.

## BATTERY EXPANSION AND USE

---

- The production date of the original batteries and newly added batteries should be as close as possible, within one year is best. If the time differences of production are too long, the battery capacity deviation will be large, and the batteries' energy cannot be fully utilised.
- Before expansion, please fully charge the original batteries to 100% (keep SOC 100%), and then charge the batteries that need to be added to SOC 100%. Next, assemble to achieve the purpose of expansion. The original batteries can be charged using an inverter; The newly added batteries need to be charged separately with the battery charger.
- Please consult relevant technical personnel before expansion. The individual will bear all consequences caused by personal misoperation, not covered by the Sunsynk warranty.
- Sunsynk lithium battery is prohibited to work in Lead-acid Mode. Any failure caused by using a Lead-acid model is not covered by the Sunsynk warranty.













# SAFETY


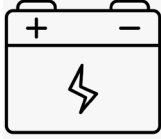

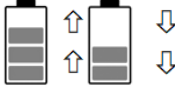



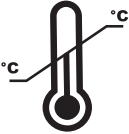


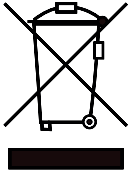


Sunsynk's products are designed with full consideration for safety. However, all electrical appliances can be dangerous if used inappropriately; they can cause a fire or electric shock, leading to severe injury or death. For your protection, please read these safety precautions thoroughly.

## General Safety

- It is crucial and necessary to read the user manual carefully (in the accessories) before installing or using the SUNSYNK-W10.6 battery. Failure to do so or to follow any of the instructions or warnings in this document can result in electrical shock, serious injury, death, or damage to the battery, potentially rendering it inoperable.
- It is required to charge the battery every six months, and the SOC should be no less than 50% in case it is stored for a long time.
- The battery needs to be recharged within 48 hours after being fully discharged.
- Do not expose the cable outside.
- All the battery terminals must be disconnected before starting the maintenance.
- Please, contact the supplier within 24 hours if something abnormal happens.
- Do not use cleaning solvents to clean the battery.
- Do not expose the battery to flammable or harsh chemicals or vapours.
- Do not paint any part of the battery, including any internal or external components.
- Do not connect the battery with PV solar panel wiring directly.
- The warranty claims are excluded for direct or indirect damage due to the items above.
- Any foreign object is prohibited from inserting into any part of the battery.

## Symbols/Safety Signs

	This symbol indicates information that if ignored, could result in personal injury, physical damage or even death due to incorrect handling.		This product's batteries contain an explosive, self-reactive material that could blow up when heated.
	Electrical Hazard.		Read the manual.
	Danger.		Indicates that this product is recyclable.
	The Battery is heavy and can cause injury if not handled safely.		Do not place near open fire or incinerate. Do not use near heaters or hot temperature sources.
	Do not submerge the battery in water or expose it to moisture or liquid.		Do not disassemble or alter the battery in any way. Do not strike or puncture the battery.
	Do not drop, deform, or impact the battery.		Do not step or put any objects onto the battery.

	Keep out of reach of children, animals, and insects.		Li-ion Battery.
	Rechargeable.		Charging and Discharging.
	Direct Current.		Product exposure.
			Recommended Charge Instructions
	Follow the indicated temperatures.		<b>BATTERY INPUT</b> Battery Discharge Voltage, Battery Discharge Current, Input Voltage Type, Battery Discharge Power.
	Contact the supplier within 24 hours if there is anything wrong. In case of leakage contact with eyes or skin, immediately clean with water and seek help from a doctor.		Do not dispose the device, accessories, and packaging with regular waste. Follow local ordinances or contact the manufacturer for disposal guidance.
	The UKCA marking is used for products placed on the market in Great Britain (England, Scotland and Wales). The UKCA marking applies to most products for which the CE marking could be used.		CE mark is attached to the solar inverter to verify that the unit follows the provisions of the European Low Voltage and EMC Directives.

## Procedures and Precautions Before Connecting

- After unpacking, please, first check the product and packing list. Please, get in touch with the local retailer if some product is damaged or lacks parts.
- Before installation, cut off the grid power and ensure the battery is in the turned-off mode.
- Wiring must be correct, do not mistake the positive and negative cables, and ensure there is no short circuit with the external device.
- It is prohibited to connect the battery and AC power directly.
- The battery system must be well grounded, and the resistance must be less than  $1\Omega$ .
- Please ensure the electrical parameters of the battery system are compatible with related equipment.
- Keep the battery away from water and fire.

## Safety Precautions While Using

- Cut off the power and completely shut down the battery before moving or repairing the battery.
- Connecting the SUNSYNK-W10.6 battery with a different type of battery is prohibited.
- It is forbidden to put the batteries working with faulty or incompatible inverters.
- It is not permitted to disassemble the battery.
- Arc damage level 1, energy  $3\text{car}/\text{cm}^2$ .
- When the battery is too warm, the LED will flash red, and the buzzer will sound with the light. The buzzer sounds for 1s and then stops for 1s.
- Liquid fire extinguishers are forbidden. In case of fire, only dry fire extinguishers can be used.
- Please do not open, repair, or disassemble the battery except staff from SUNSYNK or authorized by SUNSYNK. We do not undertake any consequences or related responsibility because of violation of safety operation or violation of design, production, and equipment safety standards.

## Handling

- The battery should only be used as instructed.
- DO NOT use the battery if it seems broken or damaged.
- The battery is non-user-serviceable and should not be opened for repair.
- Handle the battery with care when installing or transporting it.
- Chemicals should not be used to clean the battery.

## Damaged Battery

A damaged battery should not be used and should be returned to Sunsynk or properly discarded via a recycling facility. Leaking electrolytes can cause skin irritation and chemical burns, so contact should be avoided.

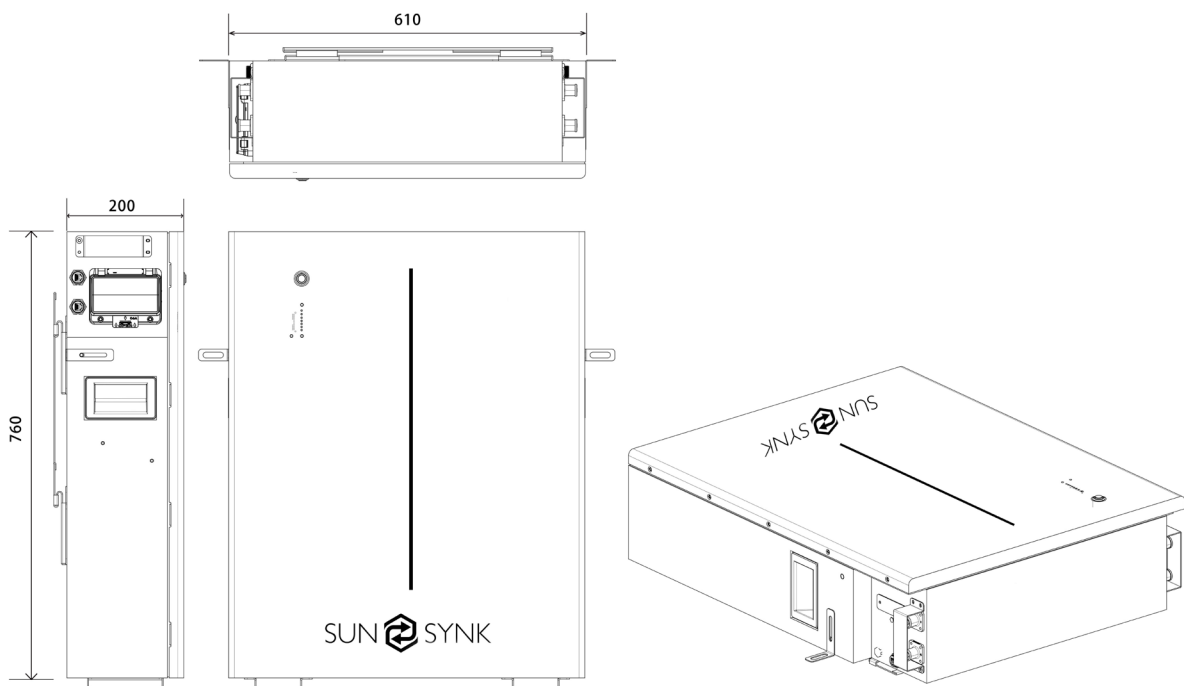
Eye	Flush eyes with plenty of water for at least 15 minutes, occasionally lifting the upper and lower eyelids. Get medical aid.
Skin	Remove contaminated clothes and rinse skin with plenty of water or shower for 15 minutes. Get medical aid.
Inhalation	Remove from exposure and move to fresh air immediately. Use oxygen if available.
Ingestion	Give at least two glasses of milk or water. Induce vomiting unless the patient is unconscious. Call a physician.

## SPECIFICATIONS AND FUNCTIONS

### Dimensions and Weight

SUNSYNK-W10.6 dimensions are presented below:

SUNSYNK-W10.6	
Depth	200mm
Width	610mm
Height	760mm
Weight	101kg

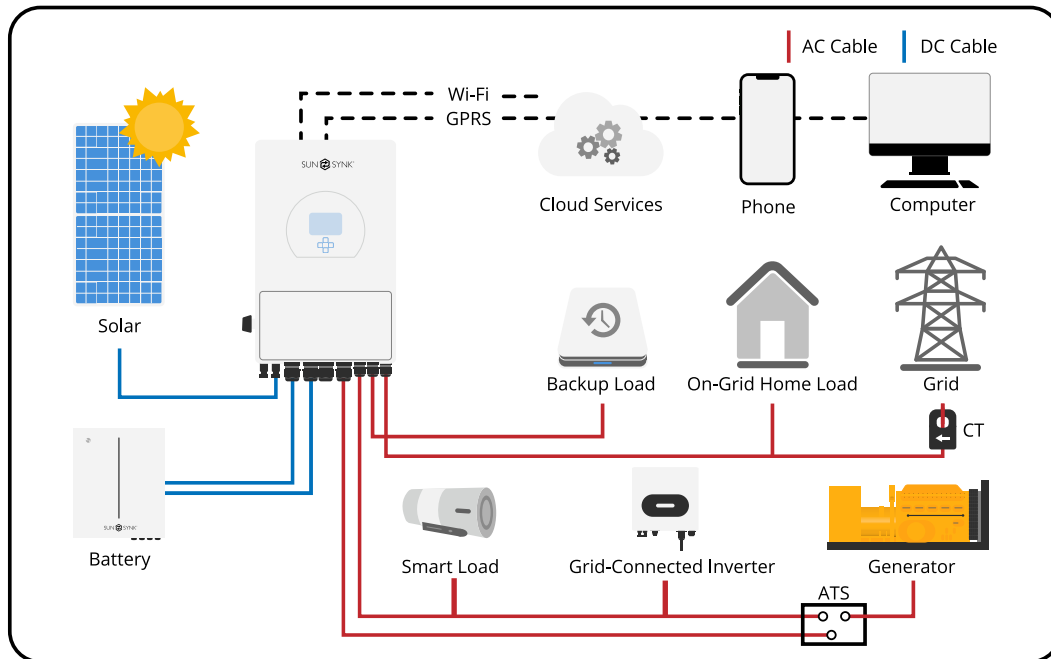


# Basic System Architecture

The following illustration shows basic application of this battery.

It also includes following devices to have a complete running system.

- Generator or Utility
- PV modules
- Hybrid Inverters (Charge & Discharge)



Contact our customer service or an accredited seller for precise information about application cases of the SUNSYNK-W10.6 battery.

## TECHNICAL DATA

Model		SUNSYNK-W10.6
Main Parameter		
Battery Chemistry		LiFePO <sub>4</sub>
Capacity (Ah)		208
Scalability		Max. 32 pcs in parallel (340kWh)
Nominal Voltage (V)		51.2
Operating Voltage (V)		43.2~57.6
Energy (kWh)		10.64
Usable Energy (kWh) <sup>1</sup>		9.58
Charge/Discharge Current (A)	Recommend <sup>2</sup>	104
	Max. <sup>2</sup>	Charge: 200 / Discharge: 240
	Peak (2mins,25°C)	Discharge: 300
Other Parameter		
Recommend Depth of Discharge		90%
Dimension (W x H x Dmm)		610 x 760 x 200 (doesn't include terminals, circuit breaker, hanging boards and pedestal)
Weight (kg)		101
Master LED Indicator		5 LED (SOC 20%~100%)
		2 LED (working, protecting)
IP Rating of Enclosure		IP65
Working Temperature		Charge: -10°C ~ +55°C Discharge: -20°C ~ +55°C
Storage Temperature		0°C ~ +35°C
Humidity		5% ~ 95%
Altitude		≤2000m
Cycle Life		≥6000 (25±2°C,90%DOD,0.5C/1C,70%EOL)
Installation		Wall-Mounted (supports 19-inch standard cabinet)
Communication Port		CAN2.0, RS485
Life Cycle Power During Warranty Period <sup>3</sup>		32MWh@70%EOL
Certification		IEC62619, CE, UK, CEC, UN38.3

<sup>1</sup> DC Usable Energy, test conditions: 90% DOD, 0.5C charge & discharge at 25° C. System usable energy may vary due to system configuration parameters.

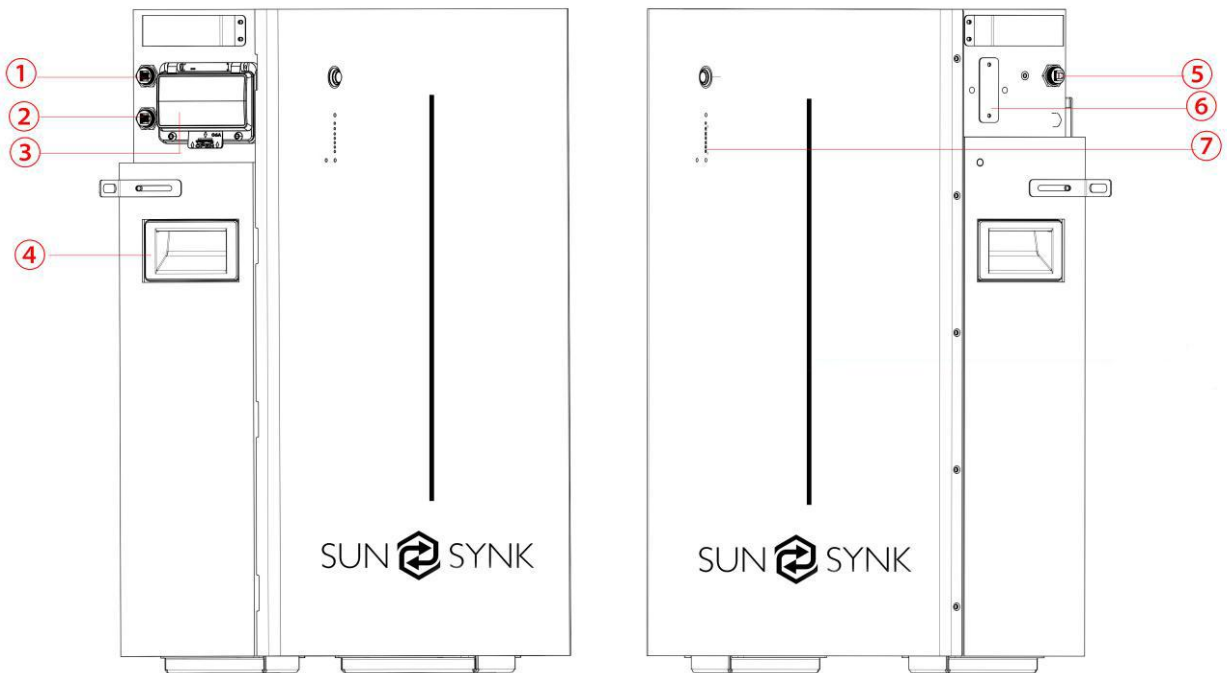
<sup>2</sup> The current is affected by temperature and SOC.

<sup>3</sup> The warranty is due whichever reached first of warranty period or energy throughout.




# EQUIPMENT INTERFACE INSTRUCTION

This section details the front and side panel of the interface functions. Following, you will find the SUN-SYNK-W10.6 front side illustration.



1. Inverter CAN/RS485 Port PCS
2. Parallel Communication Port IN
3. Micro Circuit Breaker
4. Handle

5. Parallel Communication Port OUT
6. RS232 Communication Module
7. Battery Indicators and Buzzer

Interface	Symbol	Description and Instructions
Power Switch		Power Switch to turn ON/OFF the whole battery BMS standby, no power out- put.
PCS		Inverter communication terminal: (RJ45 port) follow the CAN protocol (baud rate: 500K), used to output battery information to the inverter.
OUT		Parallel Communication Terminal: (RJ45 port) Connect "out". The terminal of the Previous battery for communication between multiple parallel batteries.
IN		Parallel Communication Terminal: (RJ45 port) Connect "in". The terminal of the Next battery for communication between multiple parallel batteries.
DC 4P 125A Circuit Breaker		Control total positive and negative circuit off and on.
Grounding Bolt 232 Communication Module		Used for the battery connecting to the PE.  The module can directly communicate with the cloud platform by inserting a Wi-Fi stick into a single pool.

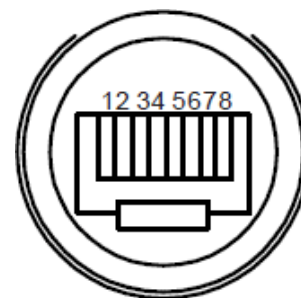
The following table presents the Led indication definition:

Condition	RUN	ALM	Error	SOC1	SOC 2	SOC 3	SOC 4	SOC 5
Power off	Off							
Charge	Blink	Blink if Alarm Exists	Off	Show SOC & highest LED blink				
Discharge or Idle			Off	Show SOC & long bright				
Alarm		Blink	Off	Other LEDs are same as above.				
System error/ Protect								
Upgrade	Blink Fast							
Critical Error	Blink Slow							

The following table presents the definition for PCS, IN, and OUT connection pins. All use the same pin number sequence shown in the next image:

Pin No.	PCS Port Definition	IN Port Definition	OUT Port Definition
1	485-B	CANL	CANL
2	485-A	CANH	CANH
3	--	DI+	DO+
4	CANH	DI-	DO-
5	CANH	DI-	DO-
6	--	DI+	DO+
7	485-A	CANH	CANH
8	485-B	CANL	CANL

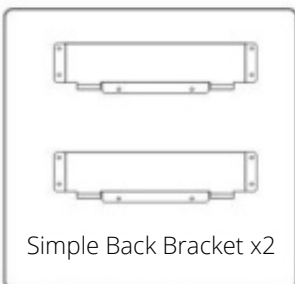
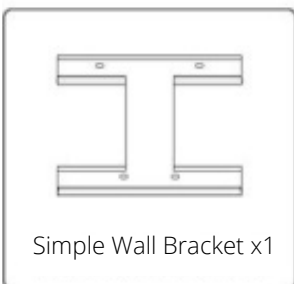
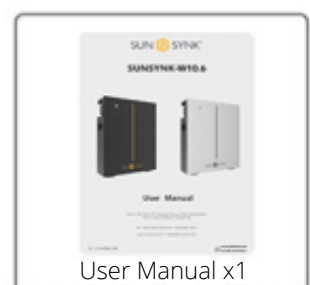
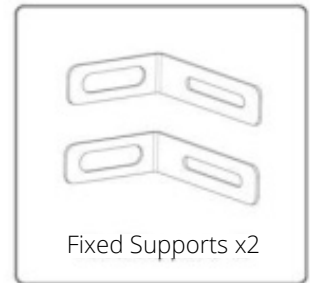
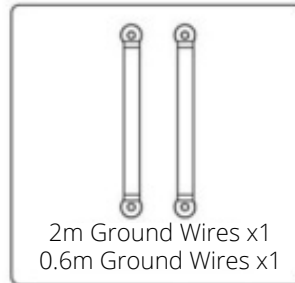
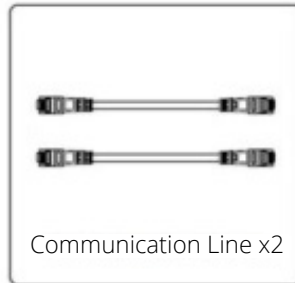
Protection and Alarm	Management and Monitor
Charge/Discharge End	Intelligent Protect Mode
Charge Over Voltage	Intelligent Charge Mode
Discharge Under Voltage	Protect, Charge Current Limit
Charge/Discharge Over Current	Intelligent Protect Mode
High/Low Temperature(cell/BMS)	Intelligent Protect Mode
Short Circuit	Protect



# INSTALLATION

## Parts List

Check if you received all the items listed below. Ensure that nothing is damaged in the package.



## Installation Precaution

The location of the battery should follow the operating temperature range and IP rating specified in the Specification section of this manual. Although the batteries run at a low temperature, proper airflow around the batteries is recommended.

When installing the set, the following conditions should be met:

- DO NOT install the product in a completely closed area with no air-conditioning. It can overheat and cause a fire.
- DO NOT place in direct sunlight or near a source of heat. This can cause deformation, a breakdown, or a fire. Pay extra attention when you place the system near windows.
- The battery must not be set where excessive oil, smoke, steam, moisture or dust is contained in the air.
- Ensure that the batteries are installed in a clean environment with minimal dust.
- Avoid installing the set near the ocean. If unavoidable, appropriate air filtration should be used to prevent salt air from in contact with the batteries.
- For proper air circulation to dissipate heat, allow a clearance of approximately 30 cm to the sides of the battery.
- DO NOT install the set near heat sources.
- DO NOT install the SUNSYNK-W10.6 in areas where highly flammable materials are stored.
- DO NOT install the SUNSYNK-W10.6 in potentially explosive areas.
- DO NOT install the SUNSYNK-W10.6 in the cool air directly.
- DO NOT install higher than an altitude of about 2000 meters above sea level.
- DO NOT install the SUNSYNK-W10.6 in an environment of precipitation or humidity (>95%).

## Selecting the Mounting Area

Make sure that the installation location meets the following conditions:

- The area is entirely waterproof.
- The wall is flat and level.
- There are no flammable or explosive materials.
- The ambient temperature is within the range of -20°C to 50°C.
- The temperature and humidity are maintained at a constant level.
- There is minimal dust and dirt in the area.
- The distance from any heat sources is more than 2 meters.
- The distance from the air outlet of the inverter is more than 0.5 meters.
- Do not cover or wrap the battery case or cabinet.
- Do not place the SUNSYNK-W10.6 in the children's or pet's reach area.
- The installation area shall avoid direct sunlight.
- The battery module has no mandatory ventilation requirements, but please avoid installation in confined areas. The aeration shall avoid high salinity, humidity, or temperature.

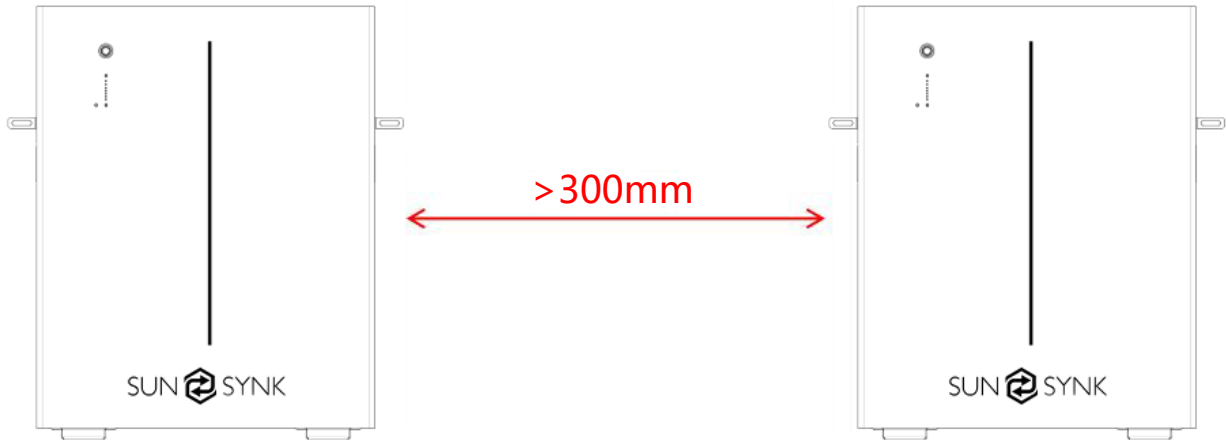


### WARNING

If the ambient temperature is outside the operating range, the battery pack stops operating to protect itself. The optimal temperature range for the battery pack is between 15°C and 35°C.

Frequent exposure to harsh temperatures may deteriorate the performance and life of the battery pack.

**Battery module parallel operation spacing diagram:**



## Tools and Safety Gears Necessary

The following tools are required to install the battery:



Torque Screwdriver



Phillips Screwdriver



Hexagon Wrench



Phillips Screwdriver



Slotted Screwdriver



Torque Wrench



Tape Measure



Driller



Pencil or Marker



### WARNING

Use adequately insulated tools to prevent accidents tale electric shocks or short circuits.

If insulated tools are not available, cover the entire exposed metal surfaces of the available tools, except their tips, with electrical tape.

We recommend wearing the following safety gear when dealing with the battery pack installation or maintenance.



Safety Gloves



Safety Goggles



Safety Shoes

# Mounting the Battery



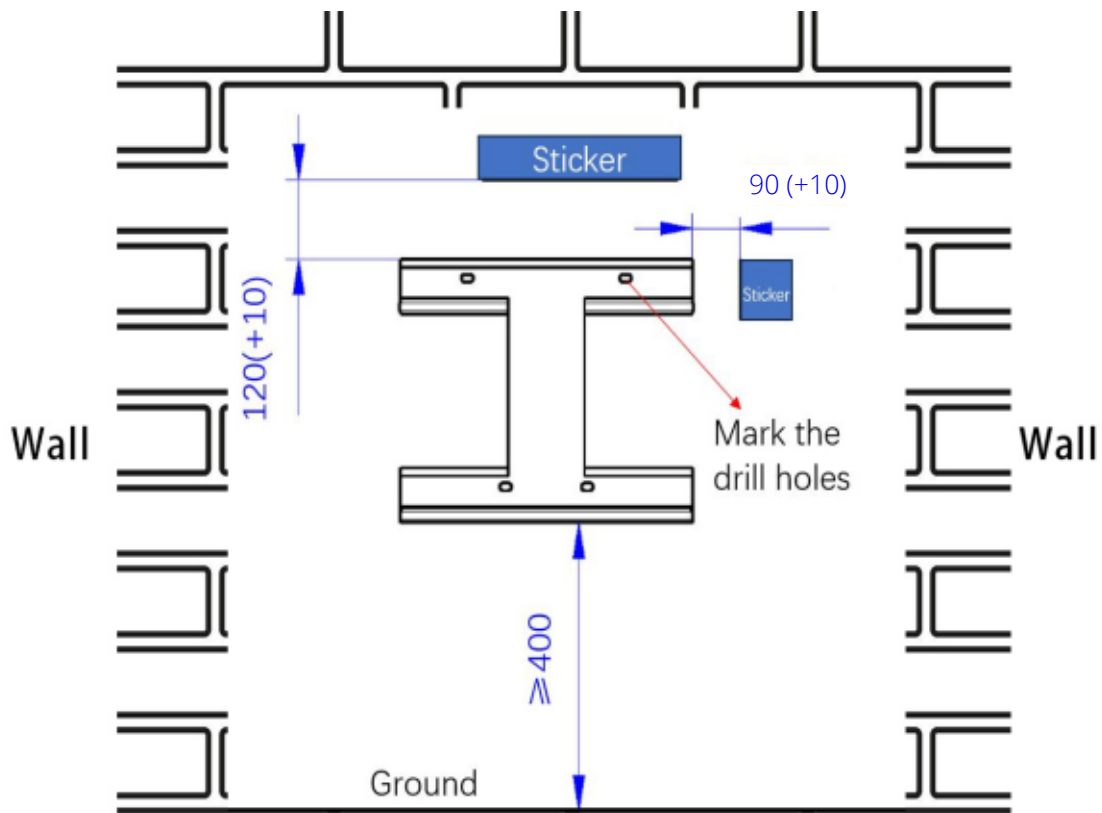
## WARNING

Risk of injury (Heavy Object).

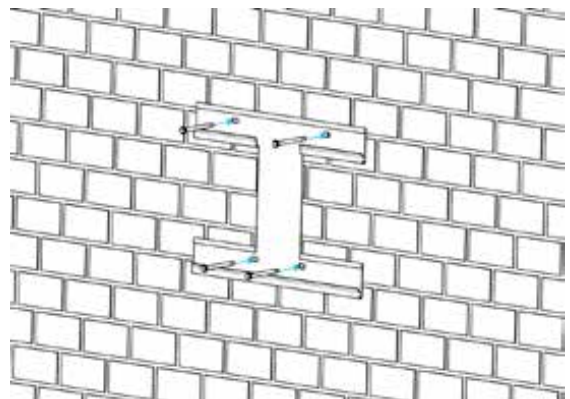
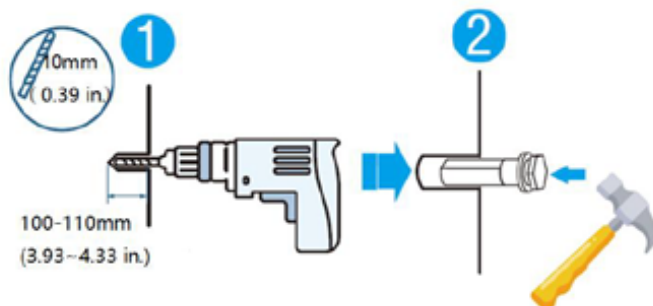
Remember that this storage system is heavy (101kg), so users must carefully handle the unit during installation, especially when mounting or removing it from the wall.

## Wall-Mounted Method

1. Maintain a distance of at least 400mm from the ground. After securely fixing the wall bracket, affix a sticker on the right side (between 90 and 95mm) and another on top (between 120 and 130mm). Mark the drill hole locations accurately as shown in the diagram below, ensuring the installation location meets the specified size requirements.



2. Select the recommended drill bit (as shown in Figure) to drill four holes in the wall, each 100mm-110mm deep. Use a suitable hammer to secure the mounting plate to the wall, inserting the M6\*100 expansion bolts into the holes as depicted in Figure below.



- Use the 10 screws of M6\*10 to fix the backplane to the back of the battery as shown in Figure 5-2.

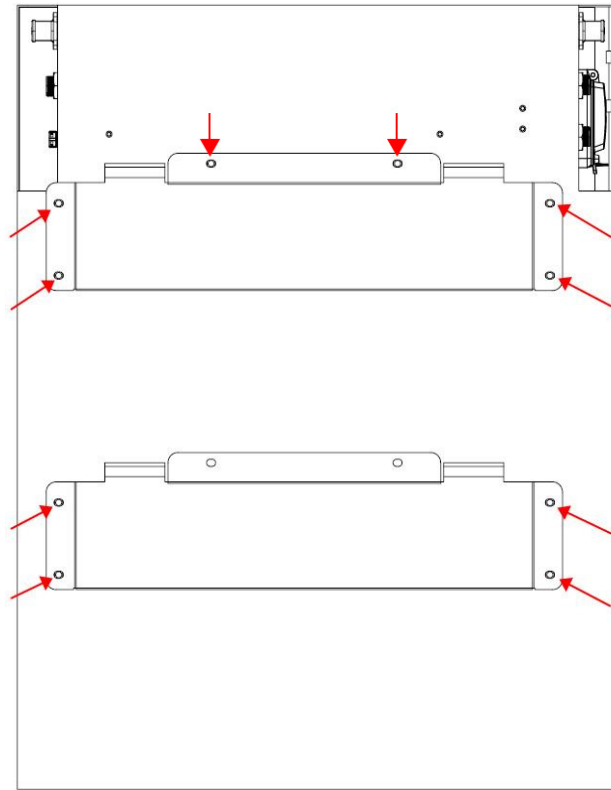
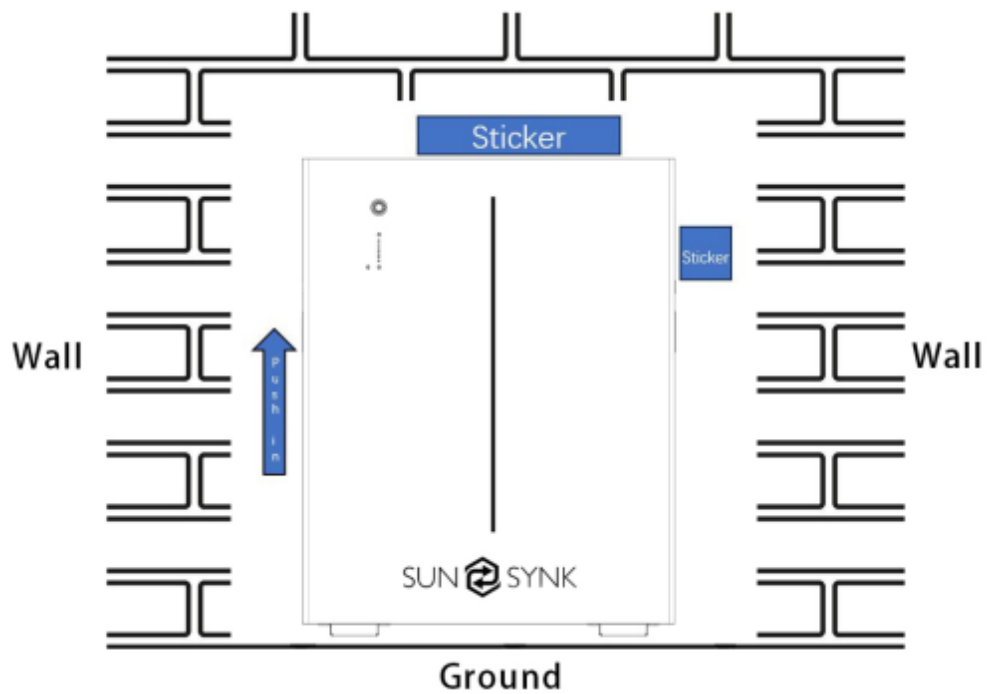


Figure 5-2

- Then lifting the SUNSYNK-W10.6 along the position of the sticker, push it on the wall bracket.



5. Tighten the screw heads of the expansion bolts to complete the mounting process.
6. Lift the battery and secure it by attaching it to the plate after fixing the mounting plate to the wall. Ensure the upper and lower positions of the battery backplane hook accurately engage with the mounting plate, as illustrated in Figure 5-3.

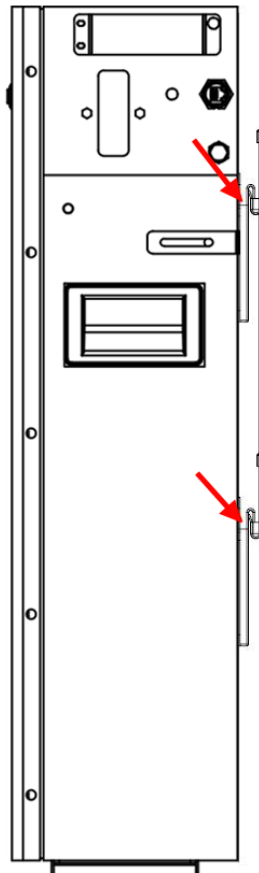


Figure 5-3

## Floor-Mounted Method

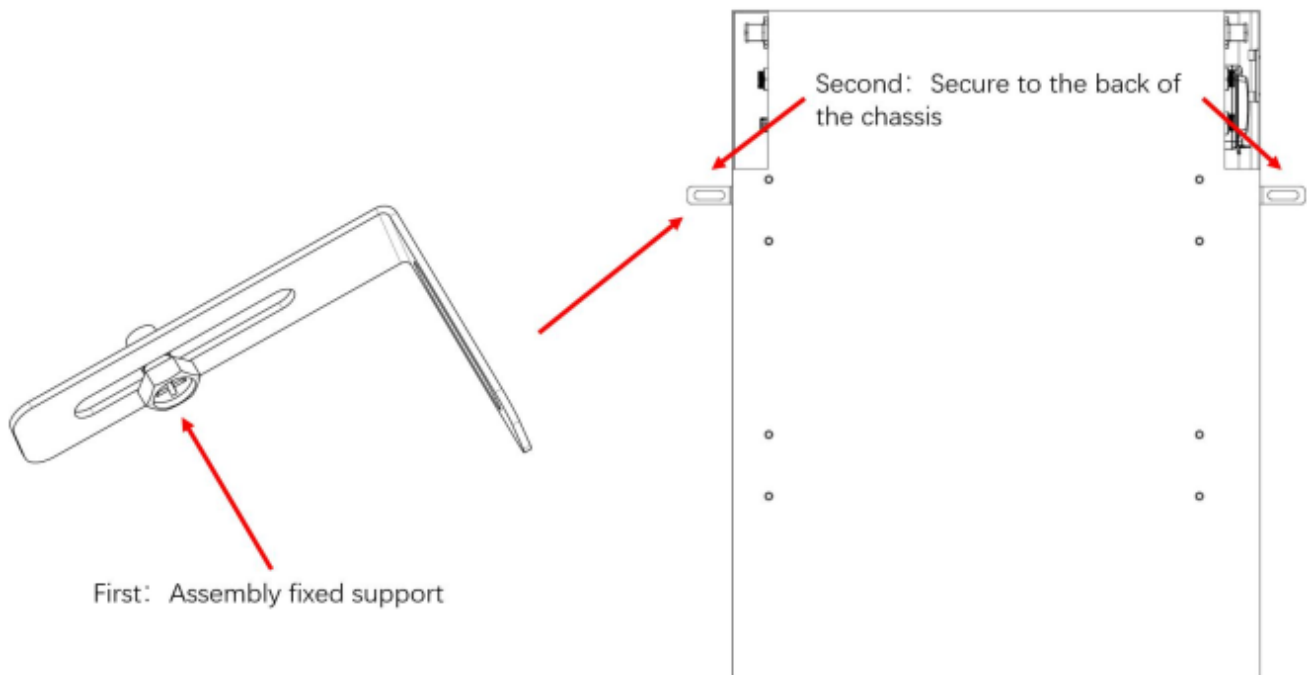
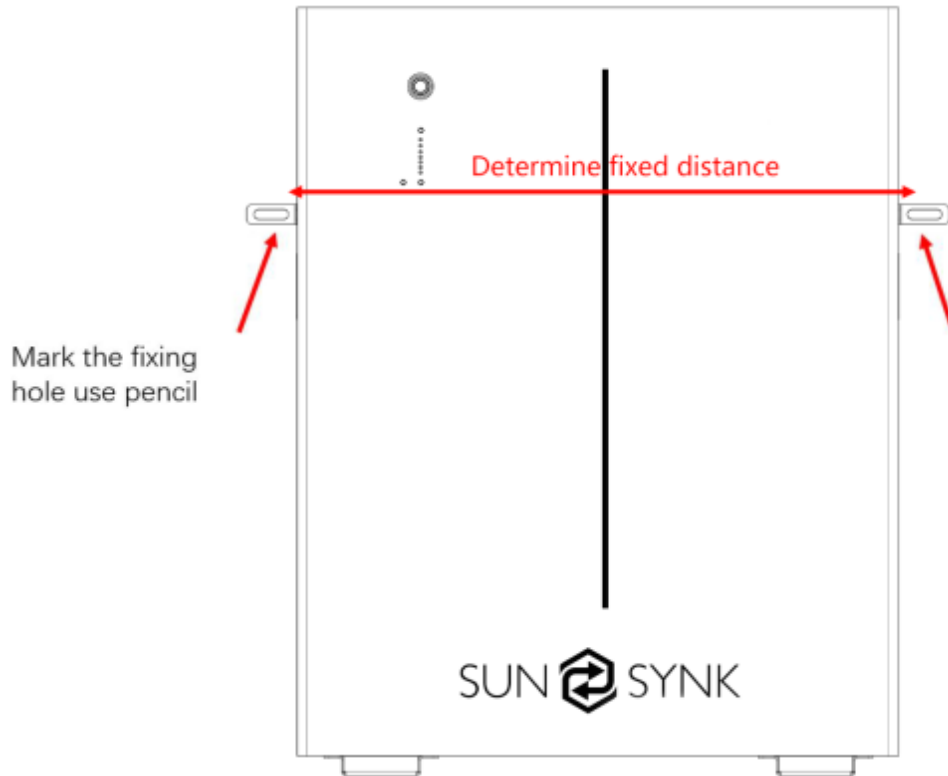


Figure 5-4

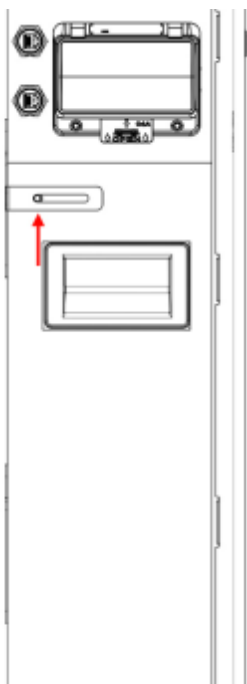


1. Stand the battery on the side of the wall, mark the location of the fixing hole.
2. Choose the recommended drill head (as shown in the figure below) to drill two holes in the wall, 100 to 110 mm deep, as shown in Figure 5-2 and Figure 5-5.

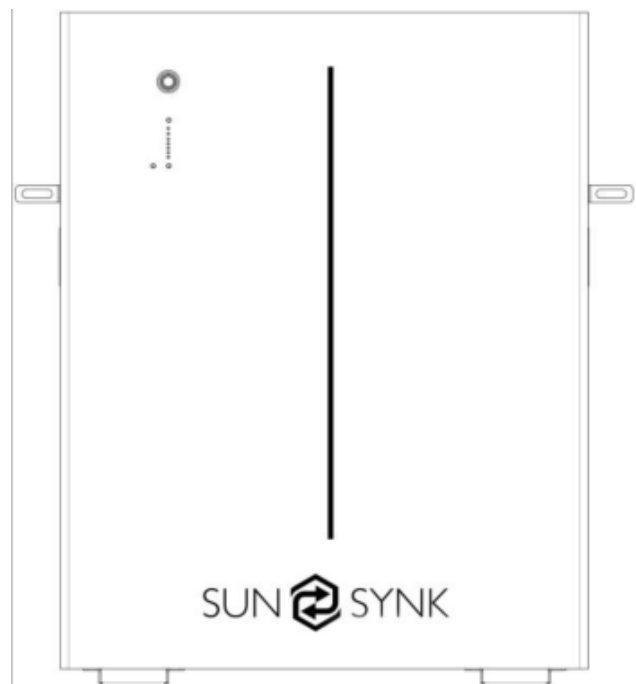


**Figure 5-5**

3. Use a proper hammer to fixing the battery to the wall, fit the expansion bolt into the holes, as shown in Figure 5-2.
4. Adjust the left and right screws to the appropriate position to ensure that the battery is perpendicular to the ground, as shown in Figure 5-6.
5. The installation results are as Figure 5-7.



**Figure 5-6**



**Figure 5-7**

# Batteries in Parallel

## Parallel Mode 1 (Inverter Power $\leq 15\text{kW}$ )



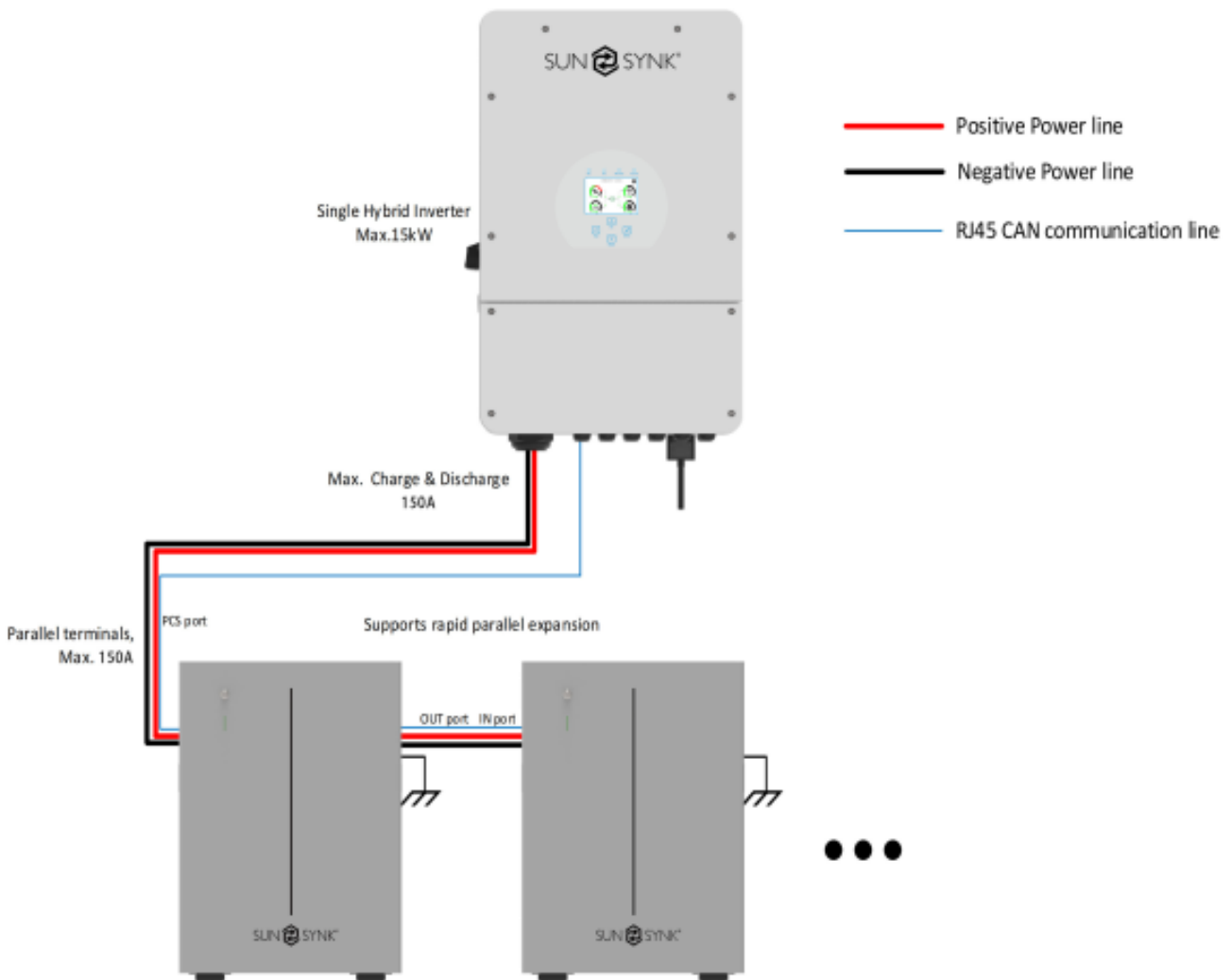
### CAUTION

The cross-sectional area of the cable must be at least 35 square millimeters.

The maximum current for each battery is 250A. Exceeding this limit can lead to overheating of connectors and cables, potentially causing fire accidents.

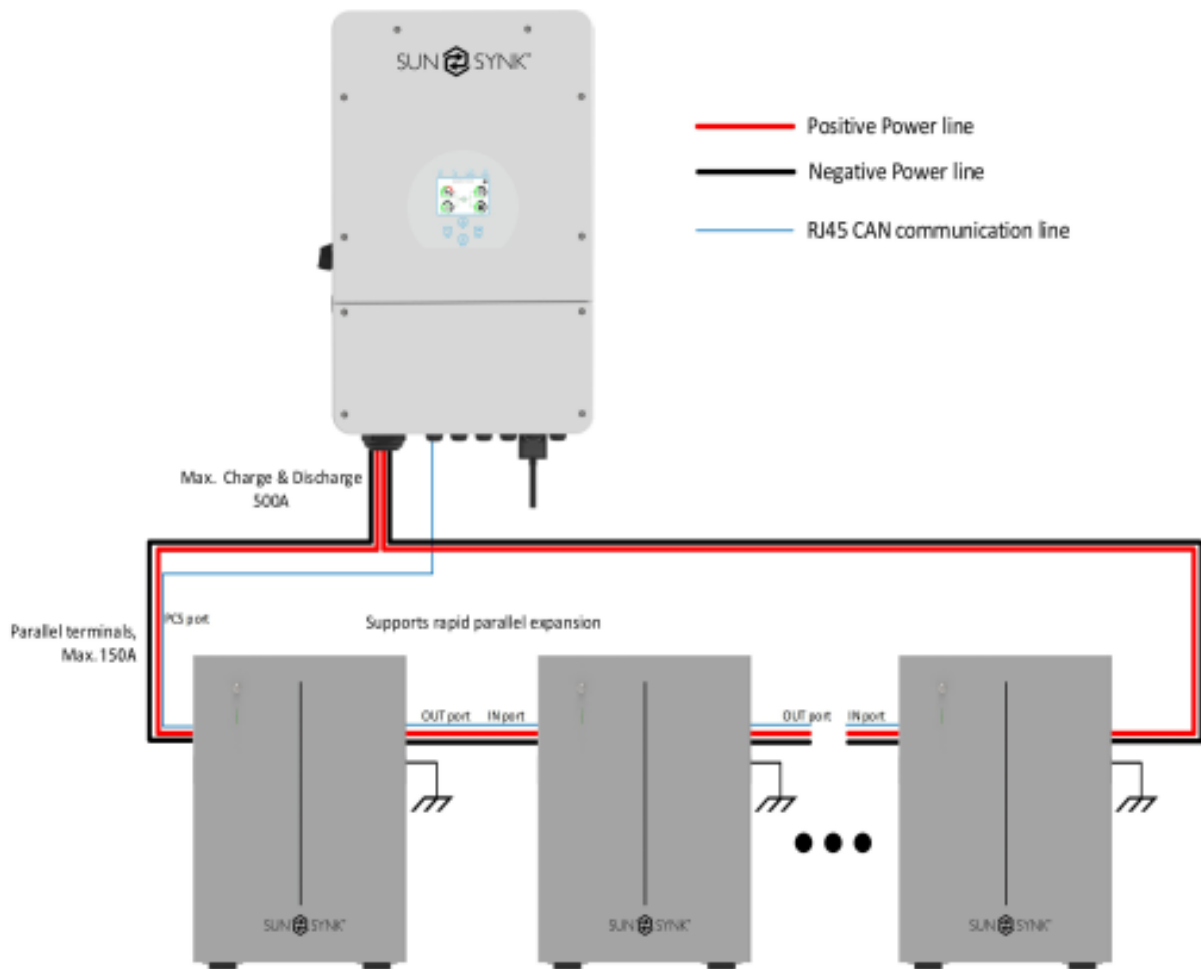
If the inverter power exceeds 15kW, it must operate in parallel mode 2.

Schematic diagram of parallel connection of low-power system batteries:

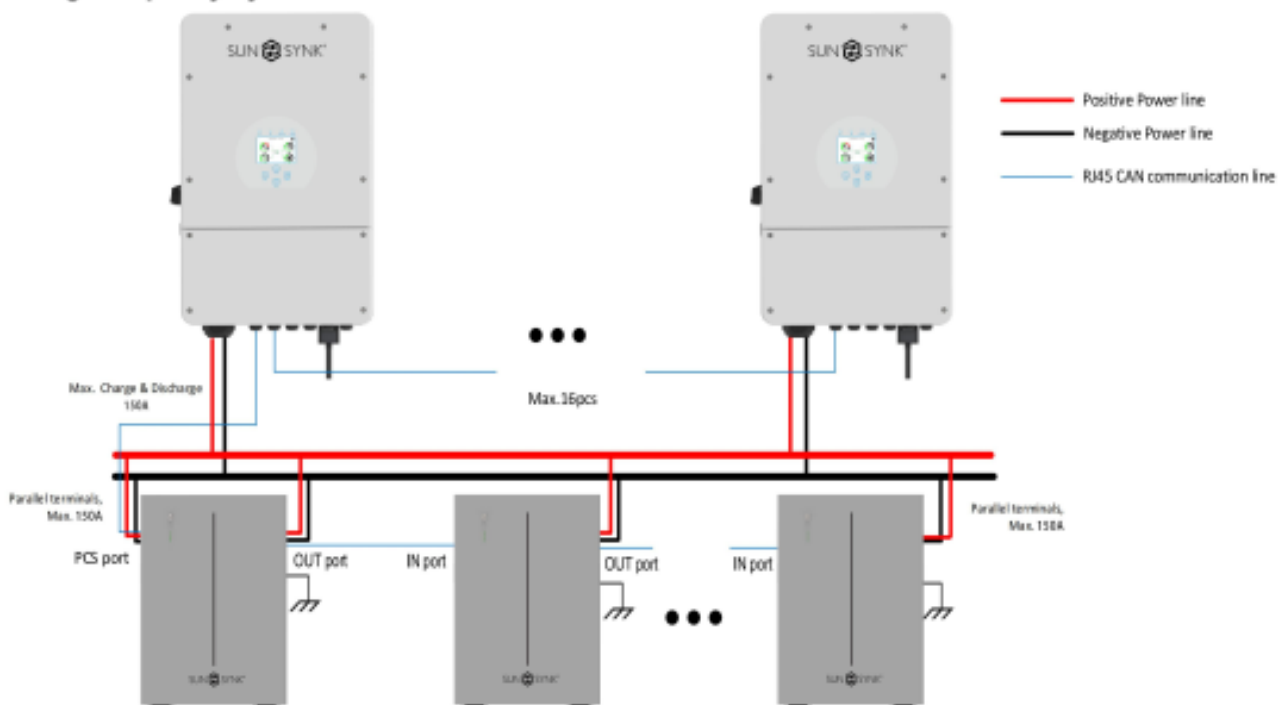


## Parallel Mode 2 (Inverter Power >15kW)

Schematic diagram of parallel connection of high-power system batteries:

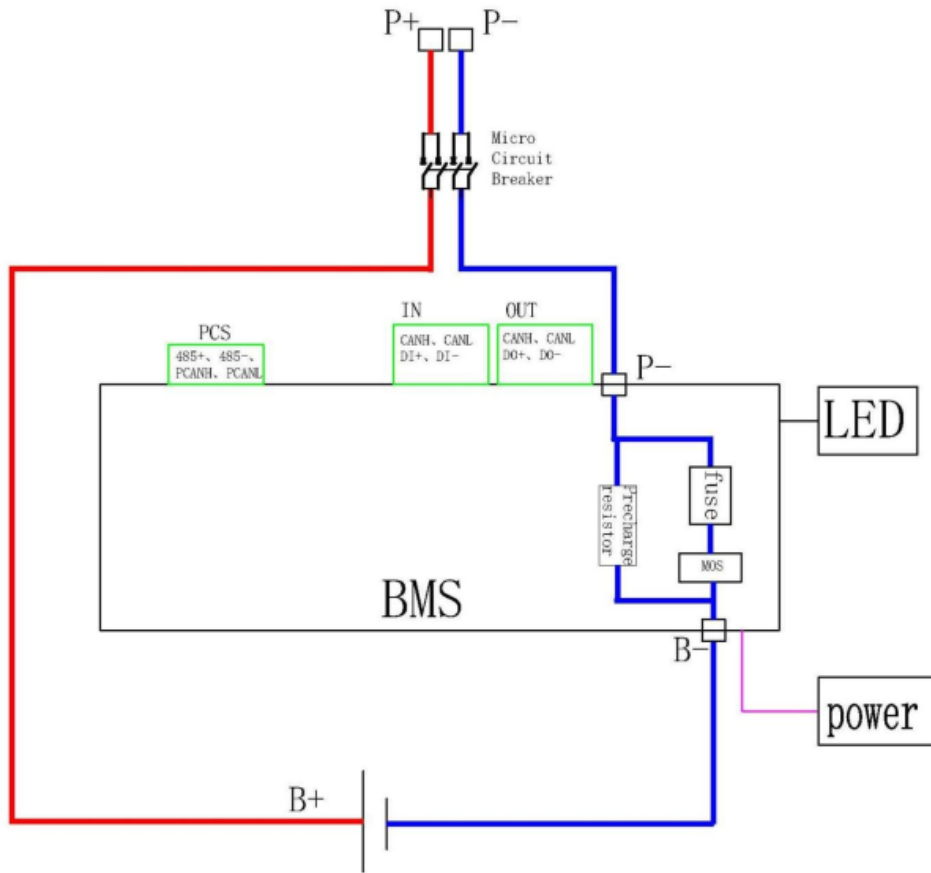


or larger capacity systems:



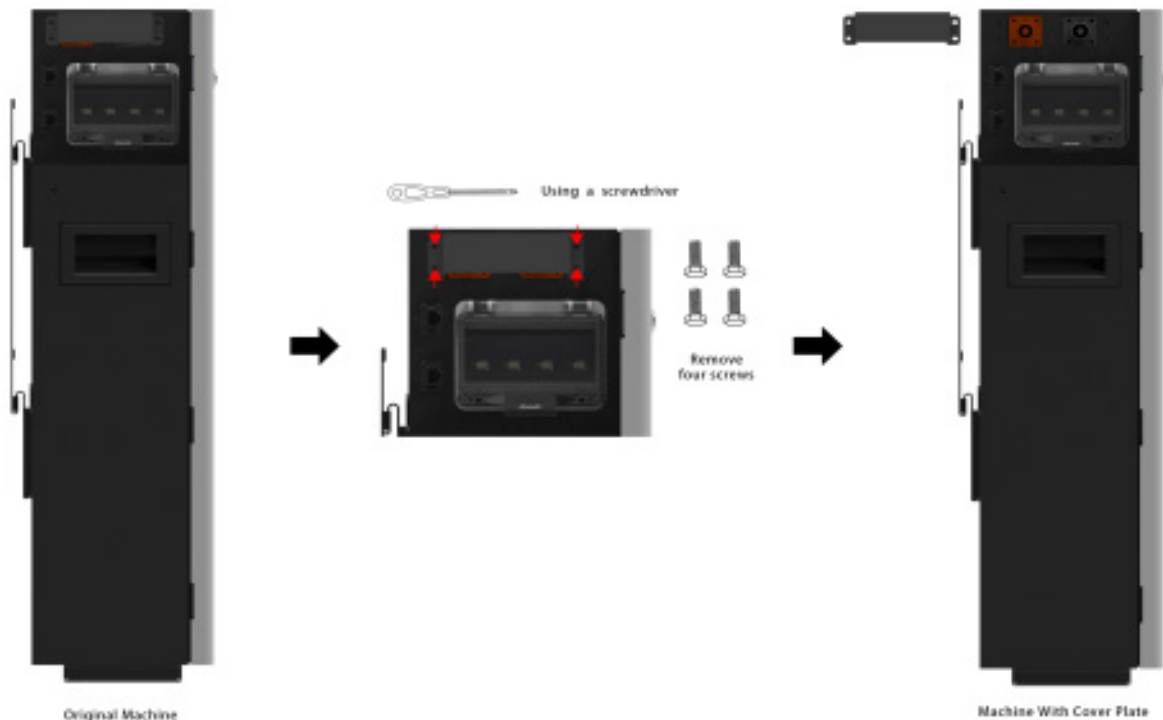
# Electrical Schematic Diagram

This diagram is for each battery module

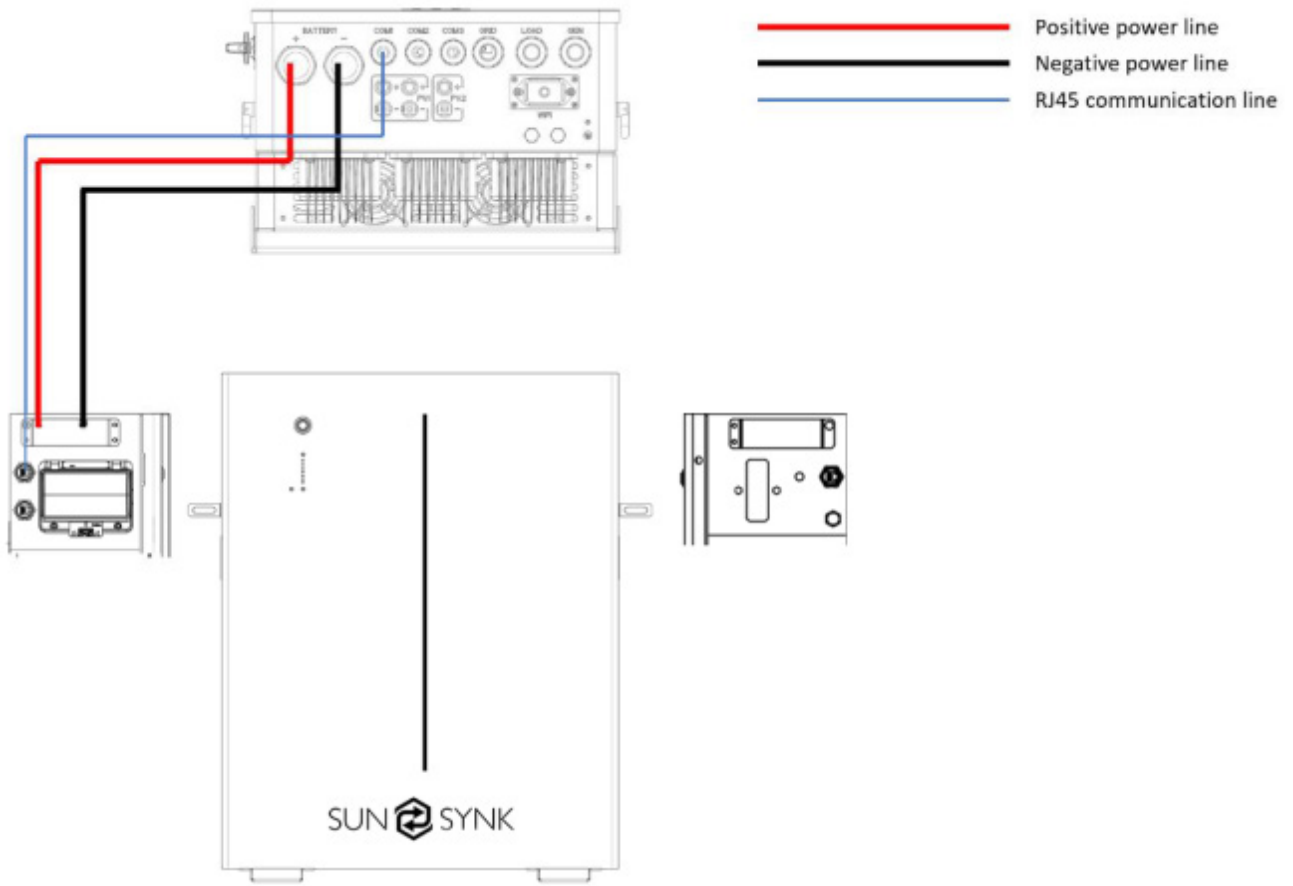


## Battery Connected to Inverter

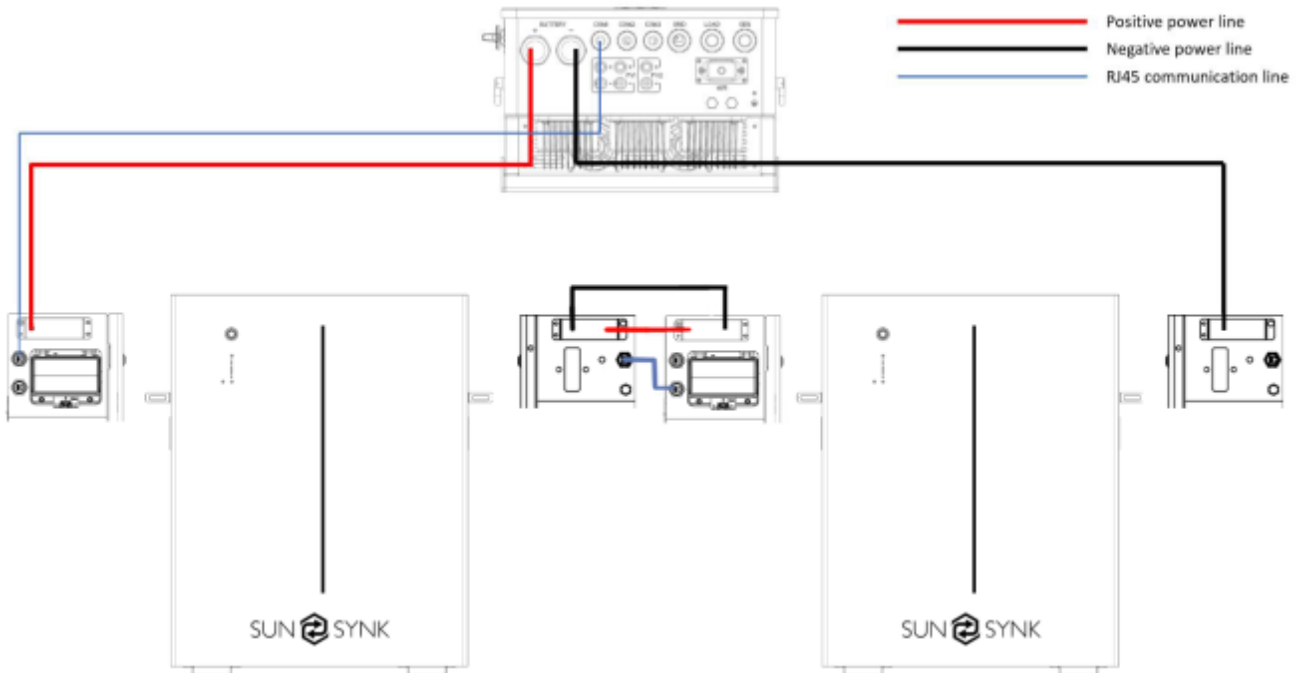
For the Australian market, it is mandatory to install an overcurrent protection and isolation device that simultaneously isolates both positive and negative conductors between the battery system and inverter. Remember to remove the cover using a screwdriver before connecting the cables.



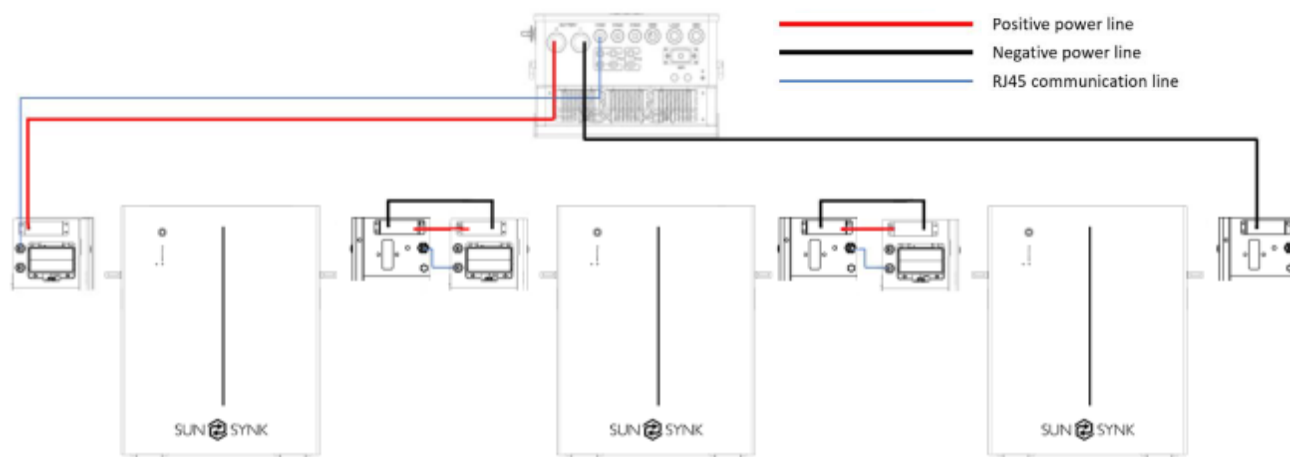
## Single Battery Connected to Inverter



## Two Batteries Connected to Inverter



## Three Batteries Connected to Inverter



## Connection Inspection

After installing and connecting the battery, check the following points:

- Usage of positive and negative cables.
- Connection of the positive and negative terminals.
- All the bolts are tightened.
- Cables fixation and appearance.
- The setting of the dialling address.
- The installation of the protecting cover.
- After cables are connected, use a screwdriver to secure the cover.

# Starting the SUNSYNK-W10.6 Battery

After completing installation, wiring, configuration, and checking all the connections, you can start the battery.

## Startup Procedure for SUNSYNK-W10.6 Lithium Battery:

1. Safety Check:
  - Ensure all personnel are clear from the vicinity of the battery installation area.
  - Confirm that all necessary safety equipment is readily available.
2. External DC Isolator Check:
  - Verify that the external DC isolator between the battery and inverter is in the OFF position.
  - Check that the isolator between parallel batteries is also in the OFF position.
3. Battery Connection:
  - Connect the SUNSYNK-W10.6 Lithium battery to the inverter using the appropriate DC cables.
  - Ensure the connections are tight and secure.
4. Inverter Initialization:
  - Turn on the inverter according to the manufacturer's instructions.
  - Allow the inverter to complete its startup sequence.
5. External DC Isolator Activation:
  - Switch ON the external DC isolator between the battery and inverter.
  - Verify that the isolator is securely engaged in the ON position.
6. System Check:
  - Monitor the inverter's display panel or software interface to confirm the successful detection of the battery.
  - Ensure that the battery status indicators show a proper connection and charge level.
7. Functionality Verification:
  - Test the system by running a small load initially and gradually increasing it.
  - Confirm that the inverter is drawing power from the battery as expected.
  - Check for any abnormal noises, vibrations, or error messages on the inverter.
8. Final Inspection:
  - Conduct a visual inspection of all connections and components to ensure everything is secure and properly installed.
  - Double-check that all safety protocols have been followed.



## Shutdown Procedure for SUNSYNK-W10.6 Lithium Battery:

1. Load Reduction:
  - Gradually reduce the load on the system by turning off non-essential appliances or equipment.
2. External DC Isolator Deactivation:
  - Switch OFF the external DC isolator between the battery and inverter.
  - Ensure that the isolator is securely in the OFF position.
3. Inverter Shutdown:
  - Turn OFF the inverter following the manufacturer's instructions.
  - Allow the inverter to complete its shutdown sequence.
4. Battery Disconnection:
  - Disconnect the SUNSYNK-W10.6 Lithium battery from the inverter by removing the DC cables.
  - Ensure the connections are handled safely and with appropriate precautions.
5. Safety Check:
  - Verify that all connections are secure and that there are no signs of damage or overheating.
6. External DC Isolator Check:
  - Confirm that the external DC isolator between the battery and inverter is in the OFF position.
  - Check that the isolator between parallel batteries is also in the OFF position.
7. Final Inspection:
  - Conduct a visual inspection of the system to ensure all components are in good condition.
  - Make sure the area around the installation is clear of any debris or obstructions.
8. Documentation:
  - Record any relevant data or observations regarding the system's performance during shutdown.
  - Update any maintenance logs or documentation as necessary.

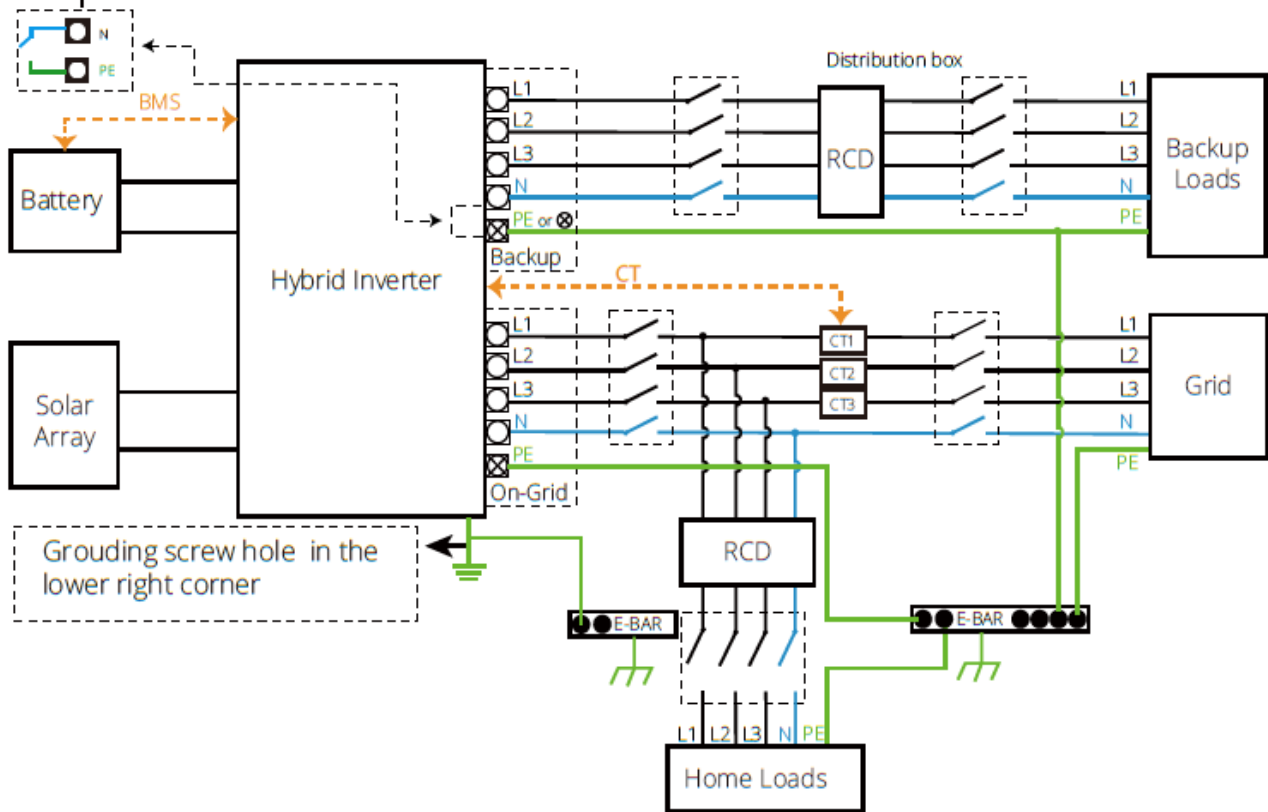


# Wiring Diagram

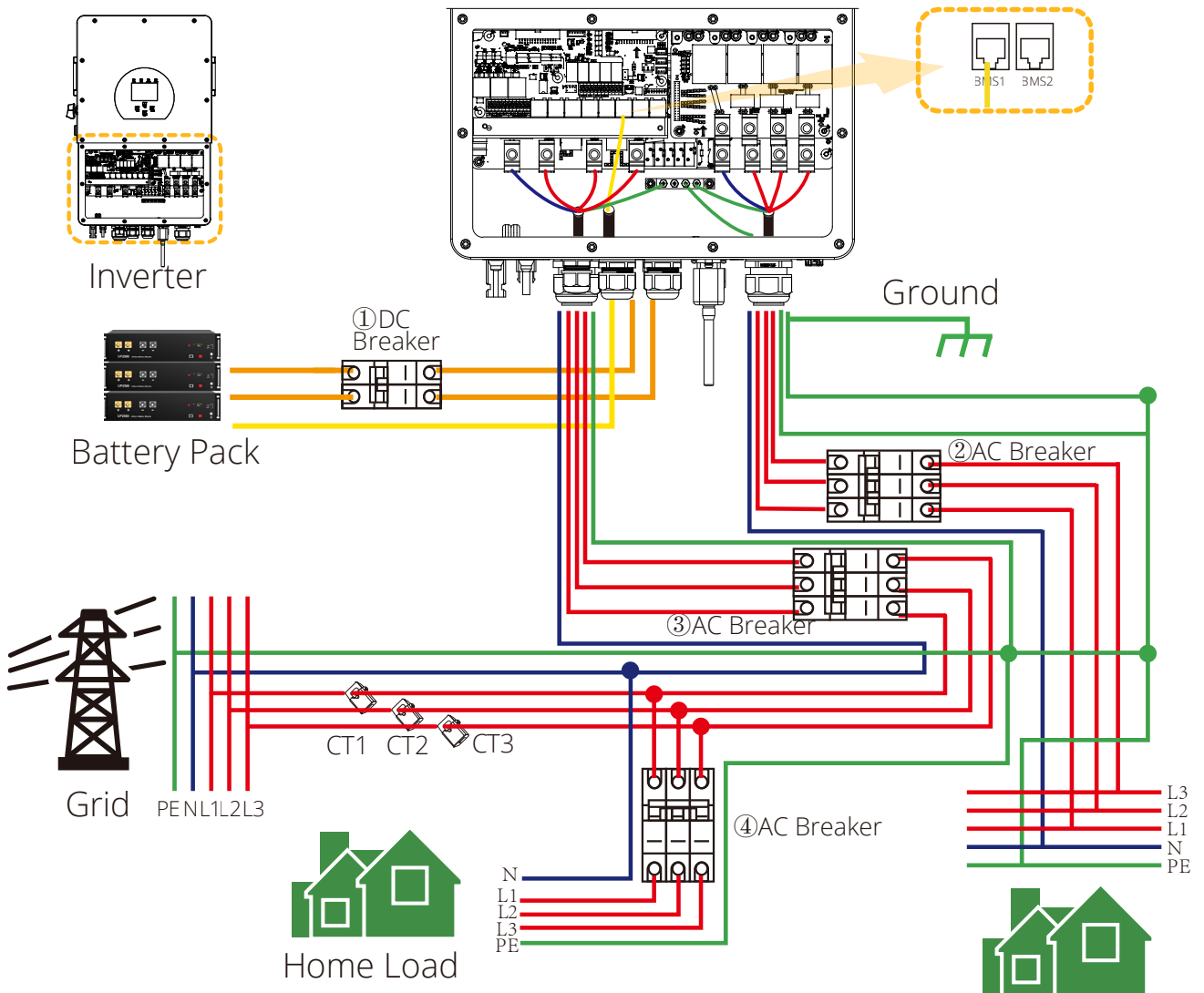
This diagram is an example for an application in which neutral is separated from the PE in the distribution box. For countries such as China, Germany, the Czech Republic, Italy, etc., please follow local wiring regulations!

Note: Backup function is optional in German market, please leave backup side empty if backup function is not available in the inverter.

When the inverter is working in backup mode, neutral and PE on the backup side are connected via the internal relay. Also, this internal relay will be open when the inverter is working in grid tied mode.

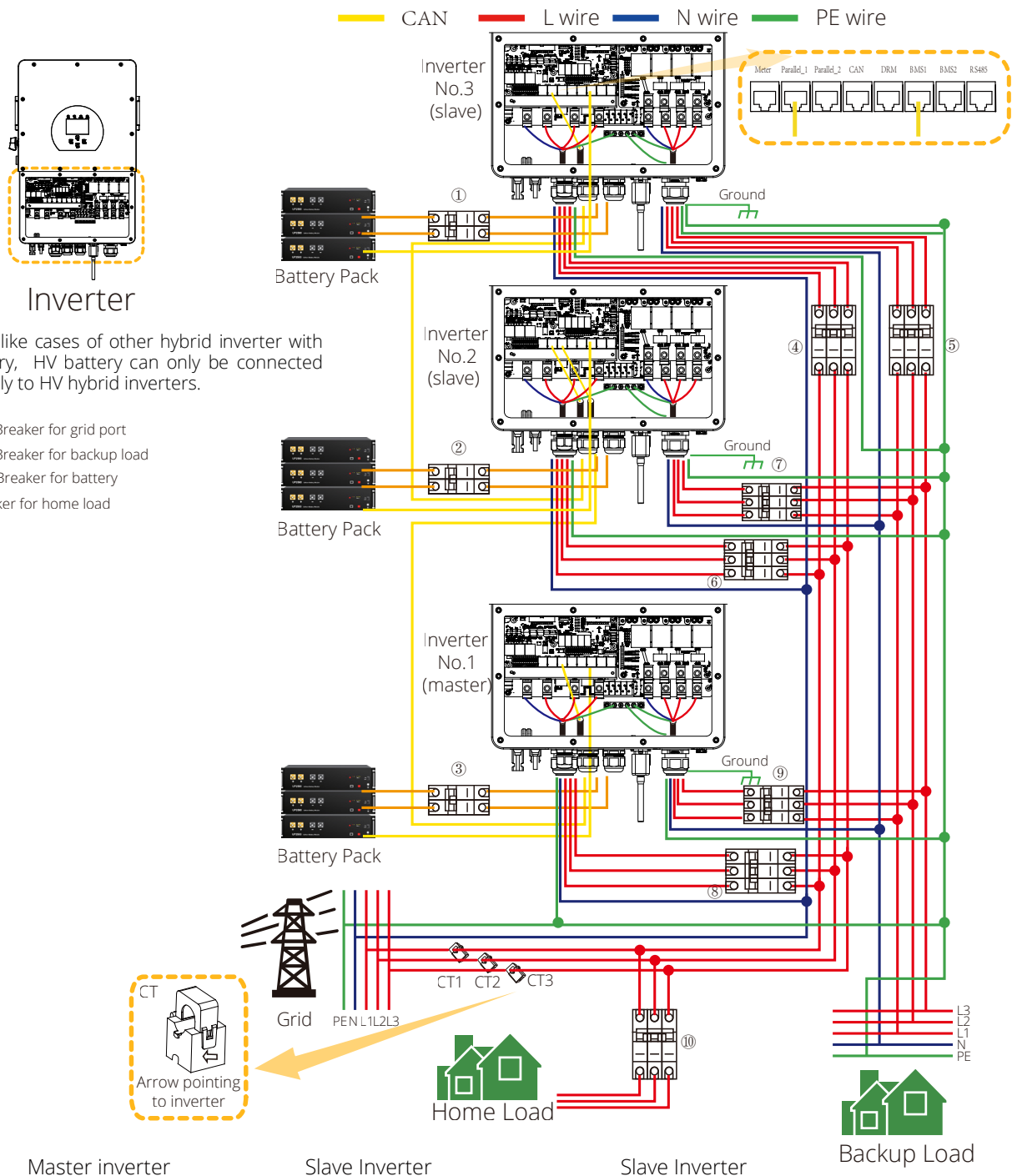


— CAN   
 — L wire   
 — N wire   
 — PE wire



- ① DC Breaker for battery
- ② AC Breaker for backup load
- ③ AC Breaker for grid
- ④ AC Breaker for home load

This image can be considered as reference to external DC isolators between battery and inverter and between parallel batteries.



Note: unlike cases of other hybrid inverter with LV battery, HV battery can only be connected separately to HV hybrid inverters.

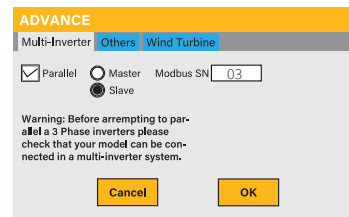
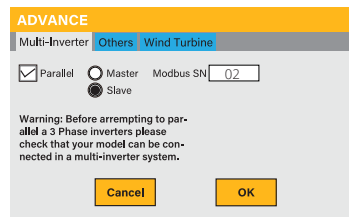
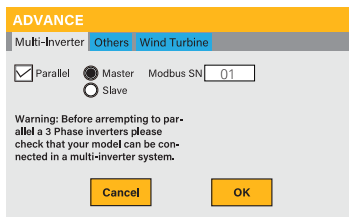
- ④⑥⑧ AC Breaker for grid port
- ⑤⑦⑨ AC Breaker for backup load
- ①②③ DC Breaker for battery
- ⑩ AC Breaker for home load

Master inverter

Slave Inverter


Slave Inverter

Backup Load
















# Symbol Explanation

Many symbols are present with the battery product and used materials to install it. Next, a list of symbols and their meanings is presented.



## DANGER/HIGH VOLTAGE INSIDE

**CAUTION:**


- Do not disassemble or alter the battery in any way.
- Do not use the battery for purposes not described in its documentation.
- Do not drop, strike, puncture, or step on the battery.
- In case of electrolyte leakage, keep leaked electrolyte away from contact with eyes or skin, immediately clean with water and seek help from a doctor.
- Do not put the battery into a fire. Do not use it or leave it in a place near fire, heaters, or high temperature sources.
- Do not submerge the battery in water, or expose it to moisture.
- Do not allow the terminals to contact exposed wire or metal.
- The battery is heavy and can cause injury if not handled safely.
- Keep out of reach of children or animals.




**No direct sunlight!**



**Keep away from heat!**



**CAUTION!**  
Do not plug or unplug the power cables when the T-BAT system is on, doing so could result in an arc discharge which could cause serious harm!



**CAUTION!**  
Ground connection is mandatory!



**WARNING**  
Handle With Care: No external force allows on BMS slot.




# MONITORING

Battery monitoring is conveniently accessible through the Sunsynk Connect App. Sunsynk inverter systems are equipped with the capability to monitor connected lithium batteries using the CANBUS protocol, ensuring continuous communication with the batteries. Users can easily access this monitoring data through the Sunsynk data logger via the Sunsynk Connect app. External monitoring is also supported for added convenience.

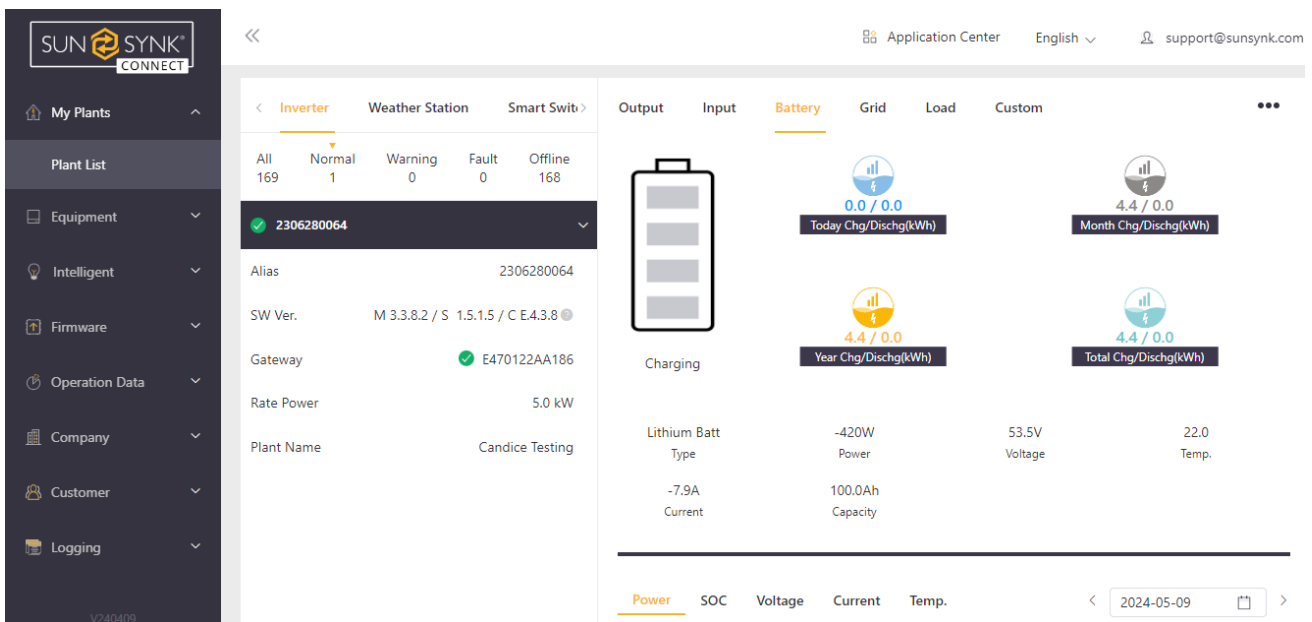
The accompanying images highlight the monitoring features of Sunsynk inverter and app systems, with a specific focus on the battery. The screens showcase the Li-BMS interface on the inverter, providing detailed insights into battery performance. The Sunsynk battery, known for its IP65 model, offers superior monitoring capabilities compared to other battery types, ensuring seamless integration with Sunsynk inverters and delivering comprehensive performance information.

Li BMS		Help ?	
Sum Data	Details Data	Sum Data	Details Data
Battery Voltage: 53.06V		Volt	Curr
Battery Current: -1A		Tem	SOC
Battery Temp: 22.0C		Energy	Charge
Total SOC: 85%			Volt
Total SOH: 100%			Curr
Battery Chage Voltage: 58.0V			Fault
Charge Current Limit: 50A		1	50.31V
Discharge Current Limit: 50A		2	50.38V
		3	50.35V
		4	50.37V
		5	50.35V
		6	50.36V
		7	00.00V
		8	50.38V
		9	50.39V
		10	00.00V
		11	00.00V
		12	00.00V
		13	00.00V
		14	00.00V
		15	00.00V

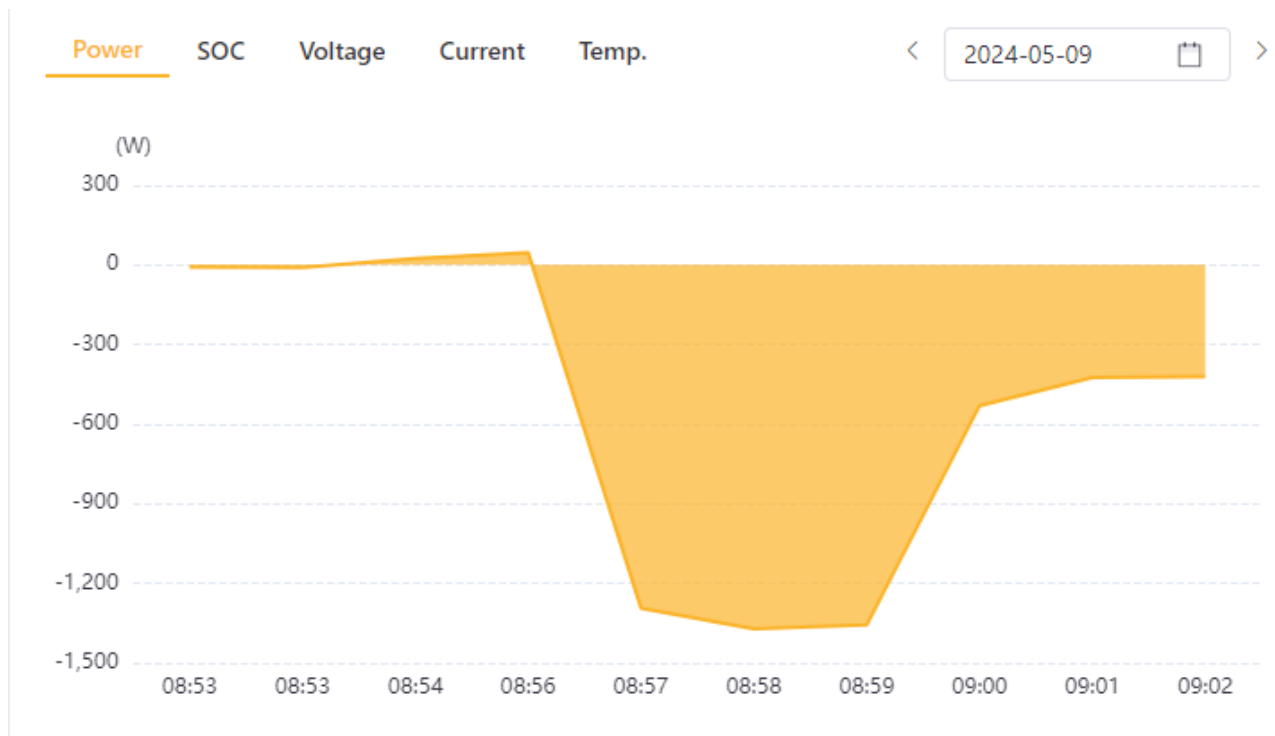
The summary data screen offers a comprehensive snapshot of the battery's current status, consolidating vital information for quick understanding at a glance.

On the other hand, the detailed data screen provides in-depth insights into the battery's specifics, including temperature readings and high/low cell voltages. This detailed view allows for a clearer understanding of the battery's internal condition and performance.

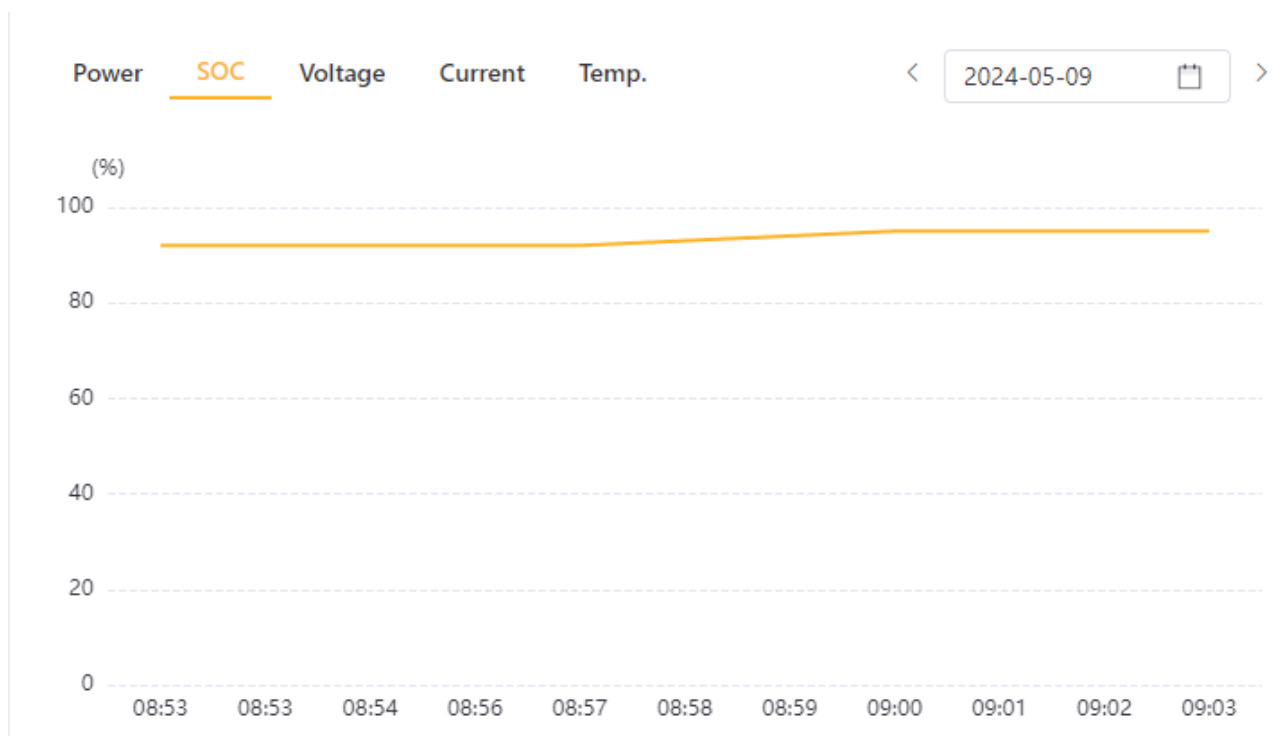
This simple Li-BMS screen offers a basic overview of the details. This screen is visible only when communication is active. For older versions of software on the battery's LCD, this screen will also show up. The newer Li-BMS display screen is available starting from LCD software E426.



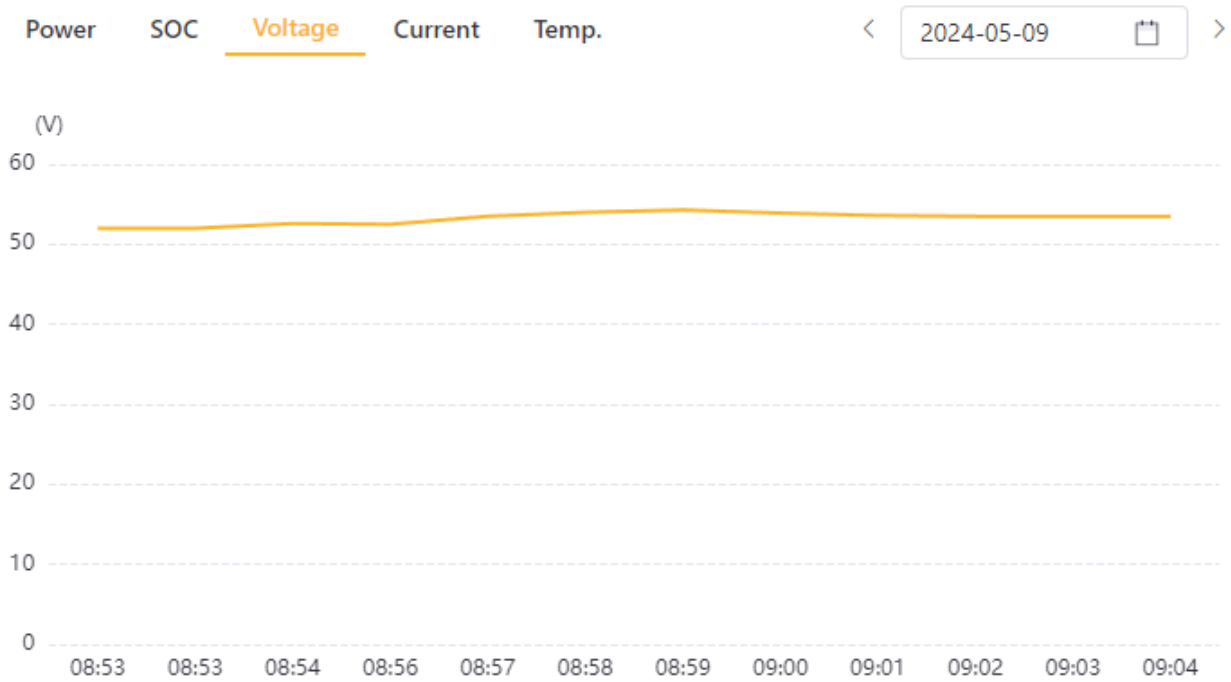
The power tab in the battery section shows the amount of power going into and out of the battery during the chosen time period. This helps you understand how much power the battery is using.



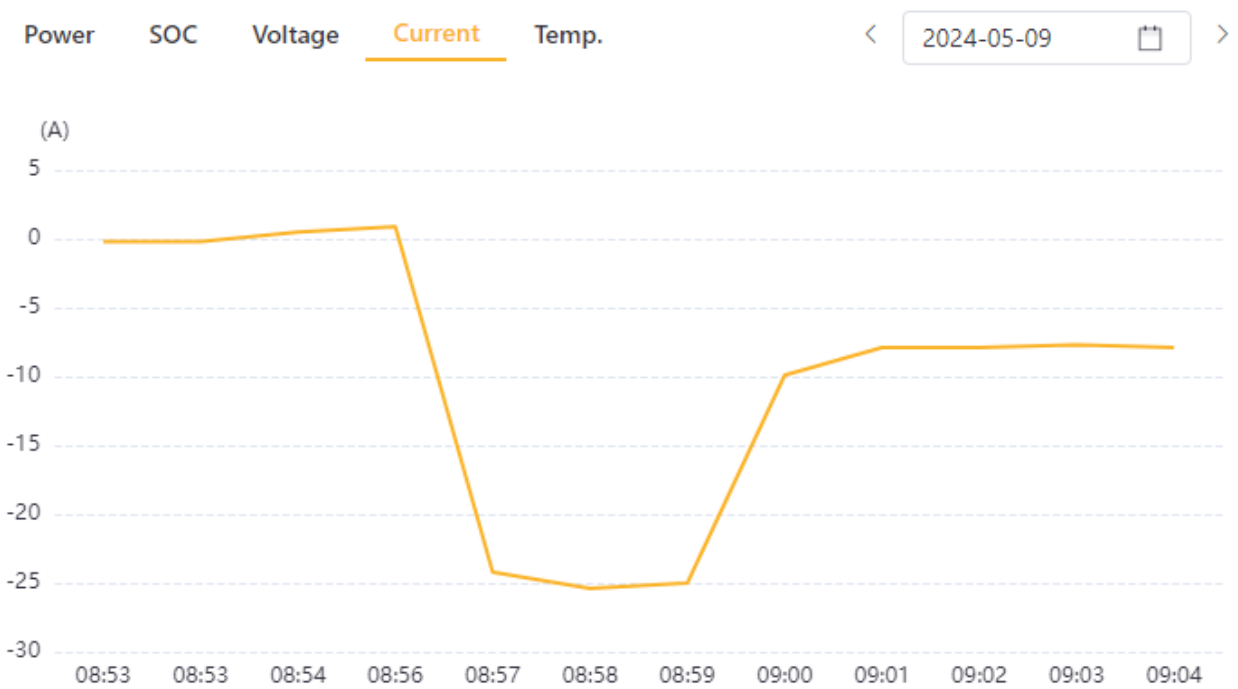
The SOC tab displays the battery's state of charge.



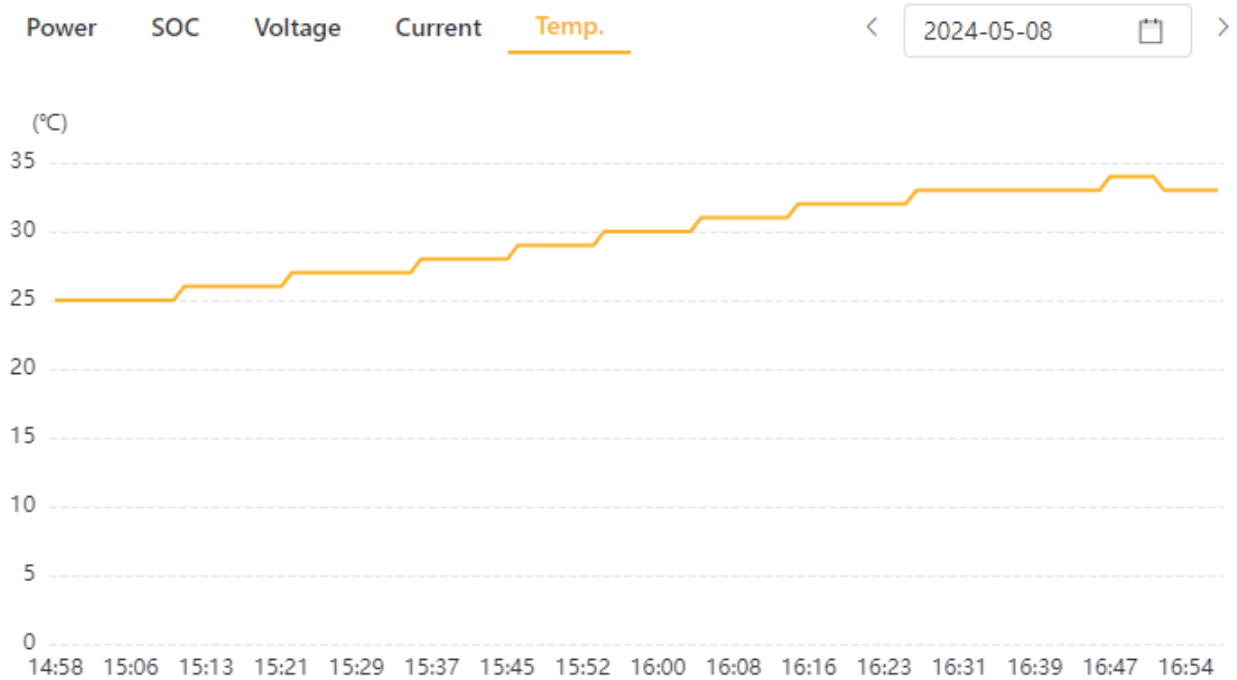
The voltage tab indicates the state of the voltage of the battery.



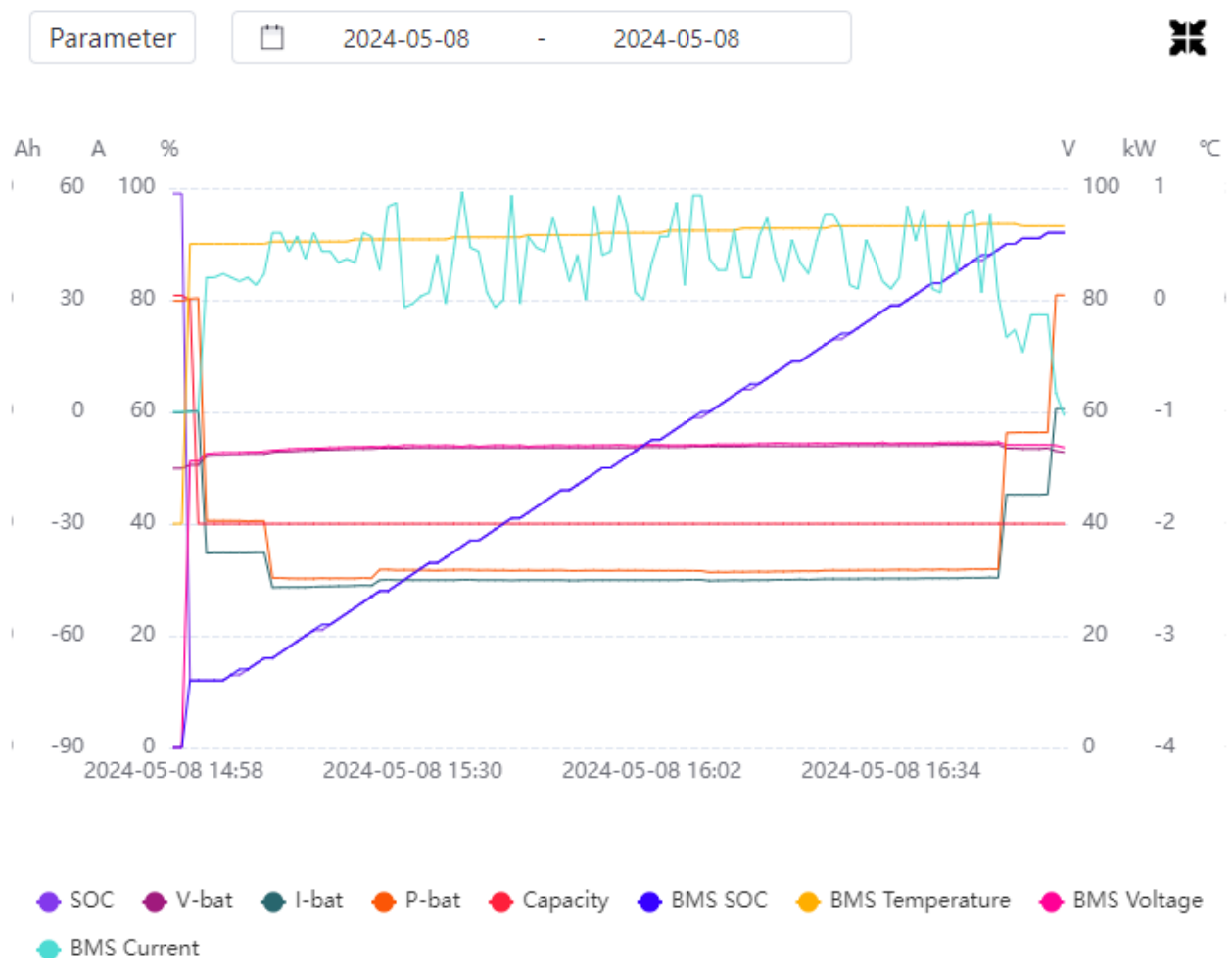
The current tab shows the current through the battery at any given time.



The temperature tab indicates the internal battery temperature of the battery according to the BMS.



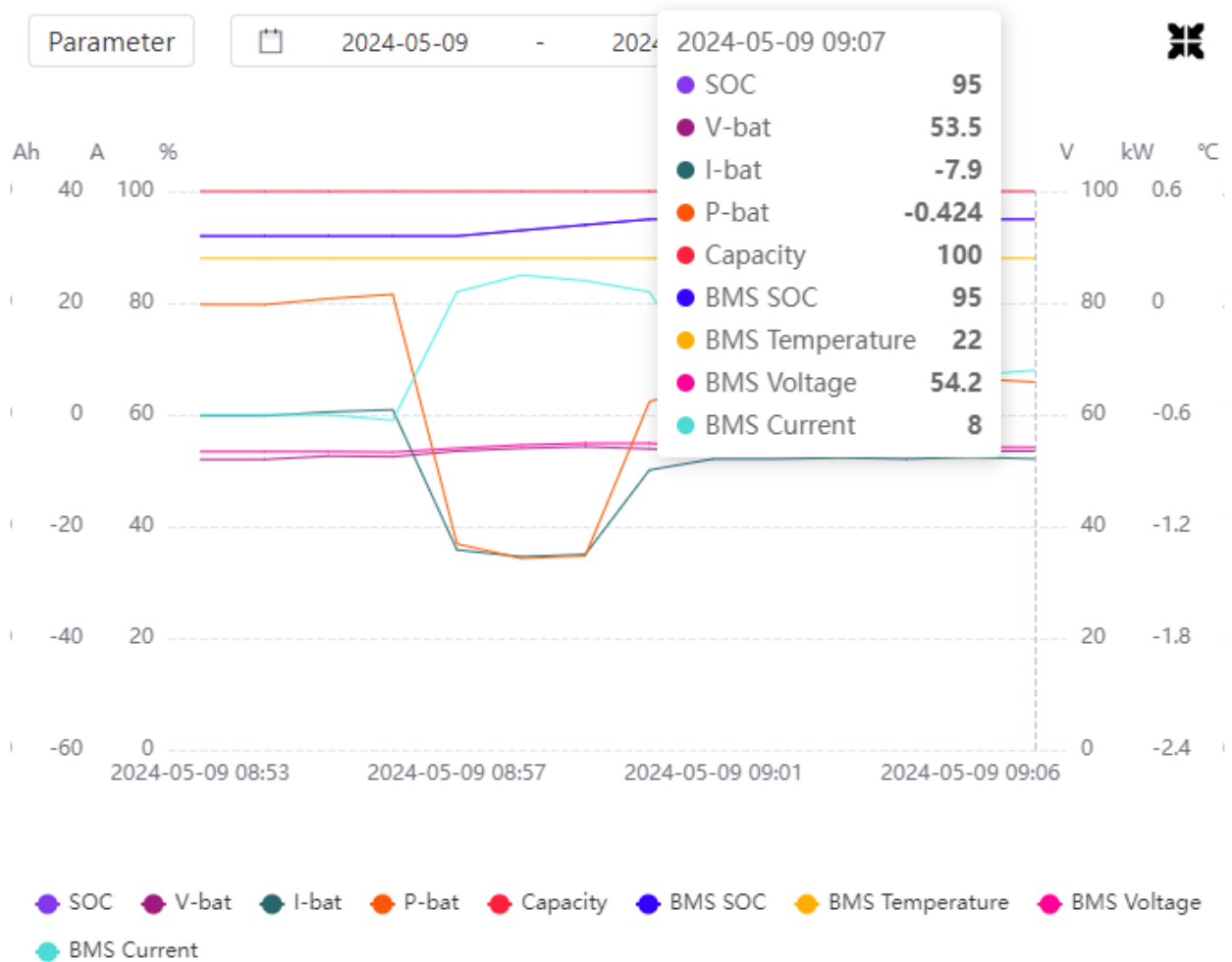
If you select the custom tab, you'll find a graph that provides detailed insights into the inverter's operations, including those related to the battery. The parameter tab grants access to all available data for the battery.





- SOC
- I-bat
- BMS SOC
- BMS Current
- Charge Current Limit
- Today Discharging
- BMS\_BatteryTempHigh
- T-bat
- P-bat
- BMS Temperature
- BMS Charge Voltage
- Discharge Current Limit
- Total Charging
- BMS\_BatteryTempLow
- V-bat
- Capacity
- BMS Voltage
- BMS Discharge Voltage
- Today Charging
- Total Discharging

The graph displays the selected options you've chosen, with a maximum of ten selections at a time. You can select and view different battery parameters for the required operational period. Hovering your cursor over the graph allows you to inspect and get more details.



# INSPECTION, CLEANING AND MAINTENANCE

## General Information

- The SUNSYNK-W10.6 battery isn't fully charged upon shipment. We suggest installing it within three months of arrival.
- During maintenance, avoid reinstalling batteries in the SUNSYNK-W10.6 to prevent reduced product performance.
- Do not dismantle or dissect any battery in the SUNSYNK-W10.6; it's strictly prohibited.
- After over-discharging the SUNSYNK-W10.6 battery, recharge it within 48 hours. You can also charge the SUNSYNK-W10.6 in parallel. Connect the charger to the output port of any SUNSYNK-W10.6 after connecting batteries in parallel.
- Do not open or dismantle the battery as it doesn't contain serviceable parts internally.
- Before cleaning or performing maintenance tasks, disconnect the SUNSYNK-W10.6 Li-Ion battery from all loads and charging devices. Use the enclosed protective caps on terminals during these activities to avoid terminal contact risks.

## Inspection

Inspect the wiring and contacts for looseness or damage, including cracks, deformations, leaks, or any other type of damage. If any damage is found, replace the battery immediately.

- Do not attempt to charge or use damaged batteries under any circumstances.

**IMPORTANT:** Avoid contact with liquid from a ruptured battery.

Regularly monitor the battery's state of charge. Lithium Iron Phosphate batteries gradually discharge when not in use or during storage. Consider replacing the battery if you notice either of the following conditions:

1. The battery's run time decreases below 70% of the original run time.
2. The battery's charge time significantly increases.

## Cleaning

If cleaning is required, use a soft, dry cloth to clean the Li-Ion battery. Avoid using liquids, solvents, or abrasives for cleaning purposes.

## Maintenance

The Li-Ion battery is maintenance-free. Charge the battery to approximately over 80% of its capacity at least once every year to maintain its capacity.

## Storage

The battery product should be stored in a dry and cool environment. Typically, the maximum storage period at room temperature is six months. If storing the battery for over six months, it's recommended to check the battery voltage. If the voltage exceeds 51.2V, you can continue storing the battery. However, it's important to check the voltage at least once a month until it drops below 51.2V. Once the voltage is lower than 51.2V, charge the battery according to the following strategy:

1. Discharge the battery to the cut-off voltage using a 0.2C (40A) current.
2. Charge the battery with a 0.2C (40A) current for approximately 3 hours.
3. Maintain the State of Charge (SOC) of the battery at 40%-60% during storage.

When storing the battery, ensure it's kept away from explosive and flammable areas, and keep ignition sources and high temperatures distant from the battery.

## TROUBLESHOOTING

To assess the battery system's status, users need to utilize additional battery status monitoring software to check the protection mode. Please refer to the installation manual for instructions on using the monitoring software. Once the user identifies the protection mode, consult the following table for solutions and further information.

Fault Type	Fault Generation Condition	Possible Causes	Troubleshooting
BMS fault	The cell voltage sampling circuit is faulty. The cell temperature sampling circuit is faulty	The welding point for cell voltage sampling is loose or disconnected. The voltage sampling terminal is disconnected. The fuse in the voltage sampling circuit is blown. The cell temperature sensor has failed.	Replace the battery.
Electrochemical cell fault	The voltage of the cell is low or unbalanced.	Due to large self-discharge, the cell over-discharges to below 2.0V after long-term storage. External factors damage the cell, and short circuits, pinpricks, or crushing occurs.	Replace the battery.
Over-voltage protection	The cell voltage is greater than 3.65 V in the charging state. The battery voltage is greater than 58.4 V.	The bus-bar input voltage exceeds the standard value. Cells are not consistent. The capacity of some cells deteriorates too fast, or the internal resistance of some cells is too high.	Contact local engineers to rectify the fault if the battery cannot be recovered due to protection against abnormality.
Under voltage protection	The battery voltage is less than 43.2V. The minimum cell voltage is less than 2.8V	The mains power failure has lasted for a long time. Cells are not consistent. The capacity of some cells deteriorates too fast, or the internal resistance of some cells is too high.	Contact local engineers to rectify the fault if the battery cannot be recovered due to protection against abnormality.
Charge or discharge high-temperature protection	The maximum cell temperature is greater than 55°C	The battery ambient temperature is too high. There are abnormal heat sources around.	Contact local engineers to rectify the fault if the battery cannot be recovered due to protection against abnormality.
Charge low-temperature protection	The minimum cell temperature is less than -10°C	The battery ambient temperature is too low.	Contact local engineers to rectify the fault if the battery cannot be recovered due to protection against abnormality.
Discharge low-temperature protection	The minimum cell temperature is less than -20°C	The battery ambient temperature is too low.	Contact local engineers to rectify the fault if the battery cannot be recovered due to protection against abnormality.

After checking the above data, please send it to our personnel service. Thus, we will evaluate your problem and reply with the best solution.

# BATTERY RECOVERY

---

The advanced hydro-metallurgical process is used to recover aluminium, copper, lithium, iron, and other metal materials from discarded  $\text{LiFePO}_4$  batteries. This process can achieve a recovery efficiency of up to 80%. Here are the steps involved in the process:

## Recovery Process and Steps of Cathode Materials

Aluminium foil, being an amphoteric metal, is dissolved in a  $\text{NaOH}$  alkali solution to form  $\text{NaAlO}_2$ , which enters the solution. After filtration, the filtrate is neutralized with sulphuric acid and precipitated to obtain  $\text{Al(OH)}_3$ . When the pH is above 9.0, most of the aluminium precipitates, and the obtained  $\text{Al(OH)}_3$  achieves chemical purity after analysis.

The filter residue is dissolved with sulphuric acid and hydrogen peroxide. This process allows lithium iron phosphate to enter the solution in the form of  $\text{Fe}_2(\text{SO}_4)_3$  and  $\text{Li}_2\text{SO}_4$ , separating it from carbon black and carbon coating on the lithium iron phosphate surface. After filtration and separation, the pH of the filtrate is adjusted with  $\text{NaOH}$  and ammonia water. Iron is first precipitated with  $\text{Fe(OH)}_3$ , and then the remaining solution is precipitated with saturated  $\text{Na}_2\text{CO}_3$  solution at  $90^\circ\text{C}$ .

Since  $\text{FePO}_4$  is slightly soluble in nitric acid, the filter residue is dissolved with nitric acid and hydrogen peroxide. This process directly precipitates  $\text{FePO}_4$  and separates impurities like carbon black from the acid solution. It also leaches  $\text{Fe(OH)}_3$  from the filter residue and precipitates  $\text{Li}_2\text{CO}_3$  with saturated  $\text{Na}_2\text{CO}_3$  solution at  $90^\circ\text{C}$ .

## Recovery of Anode Materials

The recovery process for anode materials is relatively straightforward. Following the separation of the anode plates, the purity of copper can exceed 99%. This high-purity copper can then undergo further refining to produce electrolytic copper.

## Recovery of Diaphragm

The diaphragm material is mainly harmless and has no recycling value.

## List of Recycling Equipment

Automatic dismantling machine, pulverize, wet gold pool, etc.

## TRANSPORTATION REQUIREMENTS

Transport battery products immediately after packaging using cars, trains, or ships. During transportation, avoid exposing the packaging to severe vibration, impact, or compression, as well as direct sunlight or rain.

Always ensure compliance with local, national, and international regulations before transporting Lithium Iron Phosphate batteries. Note that the transport of end-of-life, damaged, or recalled batteries may be restricted or prohibited in some cases.

The transport of Li-Ion batteries is classified under hazard class UN3480, class 9, falling into packaging group PI965 Section I for transport by water, air, or land.

For transportation of lithium-ion batteries assigned to Class 9, use Class 9 Miscellaneous Dangerous Goods and UN Identification labels. Refer to relevant transportation documents for further guidance.





## CONTACT US

**Call us:** +44 151 832 4300 **Email us:** [sales@sunsynk.com](mailto:sales@sunsynk.com)

**HK Address:** Room 702-704, 7/F Texwood Plaza, 6 How Ming Street, Kwun Tong, Kowloon, Hong Kong.

**UK Address:** Sunsynk UK Ltd, 17 Turnstone Business Park, Mulberry Avenue, Widnes, Cheshire, WA8 0WN.

**SA Address:** Globaltech Sunsynk South Africa (Pty) Ltd, Unit 2 Highview Boulevard, Ferndale 2194.

**NL Address:** Sunsynk NL BV, Henri Wijnmalenweg 8, 5657 EP Eindhoven, Netherlands.

GlobalTech Ltd



Powered by  
SUN SYNK