



SUNSYNK-L5.3



USER MANUAL

Room 702-704, 7/F Texwood Plaza, 6 How Ming Street,
Kwun Tong, Kowloon, Hong Kong

Tel: +852 2884 4318 Fax: +8522884 4816

www.sunsynk.com / sales@sunsynk.com

Table of Contents

INTRODUCTION	3
BATTERY EXPANSION AND USE	3
SAFETY	4
General Safety	4
Symbols/Safety Signs	4
Procedures and Precautions Before Connecting	5
Safety Precautions While Using	5
Handling	6
Damaged Battery	6
SPECIFICATIONS AND FUNCTIONS	6
Dimensions and Weigh	6
Basic System Architecture	7
TECHNICAL DATA	8
EQUIPMENT INTERFACE INSTRUCTION	9
INSTALLATION	11
Parts List	11
Installation Precaution	11
Selecting the Mounting Area	12
Tools and Safety Gears Necessary	13
Mounting the Battery	14
Installation	14
Connection Inspection	15
Starting the SUNSYNK-L5.3 Battery	15
Symbol Explanation	15
INSPECTION, CLEANING AND MAINTENANCE	16
General Information	16
Inspection	17
Cleaning	17
Maintenance	17
Storage	17
TROUBLESHOOTING	17
BATTERY RECOVERY	19
Recovery Process and Steps of Cathode Materials	19
Recovery of Anode Materials	19
Recovery of Diaphragm	19
List of Recycling Equipment	19
TRANSPORTATION REQUIREMENTS	20

INTRODUCTION

Thank you for choosing Sunsynk's energy storage system.

SUNSYNK-L5.3 lithium iron phosphate battery is one of the new energy storage products developed and produced by SUNSYNK. SUNSYNK-L5.3 is especially suitable for application scenarios of high power, limited installation space, and long cycle life. It can be used to support reliable power for various types of equipment and systems.

The energy storage module includes lithium-ion rechargeable batteries with 5.32kWh capacity, and the controller enables a central of multiple modules. Thus, batteries can be connected in parallel to expand capacity and power for applications that require larger capacity and longer power support.

SUNSYNK-L5.3 has a built-in BMS (battery management system), which can manage and monitor cell-battery information, including voltage, current, and temperature. Moreover, the BMS can balance cells charging and discharging to extend cycle life.

This manual provides information regarding safety precautions to prevent possible accidents and how to use the product. Please read this manual carefully before use for safety and keep this manual handy for reference.

Some main features of this product are:

- The whole module is non-toxic, non-polluting, and environmentally friendly.
- The cathode material is made from LiFePO₄ with safety performance and long cycle life.
- Battery management system (BMS) has protection functions, including over-discharge, over-charge, over-current, and high/low temperature.
- The system can automatically manage the charge and discharge state and balance the current and voltage of each cell.
- Flexible configuration, multiple battery modules can be connected in parallel for expanding capacity and power.
- Adopted self-cooling mode rapidly reduced entire system noise.
- The module has less self-discharge, up to 6 months without charging it on the shelf, no memory effect, and excellent shallow charge and discharge performance.
- Battery module communication address auto networking, easy maintenance, and support monitoring and upgrading the firmware remotely.
- High-power density: flat design, wall-mounted, and 19-inch rack-mount, saving installation space.

BATTERY EXPANSION AND USE

- The production date of the original batteries and newly added batteries should be as close as possible, within one year is best. If the time differences of production are too long, the battery capacity deviation will be large, and the batteries' energy cannot be fully utilised.
- Before expansion, please fully charge the original batteries to 100% (keep SOC 100%), and then charge the batteries that need to be added to SOC 100%. Next, assemble to achieve the purpose of expansion. The original batteries can be charged using an inverter; The newly added batteries need to be charged separately with the battery charger.
- Please consult relevant technical personnel before expansion. The individual will bear all consequences caused by personal misoperation, not covered by the Sunsynk warranty.
- Sunsynk lithium battery is prohibited to work in Lead-acid Mode. Any failure caused by using a Lead-acid model is not covered by the Sunsynk warranty.



SAFETY







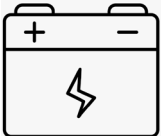

Sunsynk's products are designed with full consideration for safety. However, all electrical appliances can be dangerous if used inappropriately; they can cause a fire or electric shock, leading to severe injury or death. For your protection, please read these safety precautions thoroughly.

General Safety

- It is crucial and necessary to read the user manual carefully (in the accessories) before installing or using the SUNSYNK-L5.3 battery. Failure to do so or to follow any of the instructions or warnings in this document can result in electrical shock, serious injury, death, or damage to the battery, potentially rendering it inoperable.
- It is required to charge the battery every six months, and the SOC should be no less than 50% in case it is stored for a long time.
- The battery needs to be recharged within 48 hours after being fully discharged.
- Do not expose the cable outside.
- All the battery terminals must be disconnected before starting the maintenance.
- Please, contact the supplier within 24 hours if something abnormal happens.
- Do not use cleaning solvents to clean the battery.
- Do not expose the battery to flammable or harsh chemicals or vapours.
- Do not paint any part of the battery, including any internal or external components.
- Do not connect the battery with PV solar panel wiring directly.
- The warranty claims are excluded for direct or indirect damage due to the items above.
- Any foreign object is prohibited from inserting into any part of the battery.

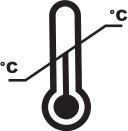
Symbols/Safety Signs

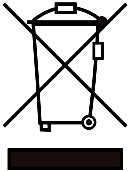
	This symbol indicates information that if ignored, could result in personal injury, physical damage or even death due to incorrect handling.		This product's batteries contain an explosive, self-reactive material that could blow up when heated.
	Electrical Hazard.		Read the manual.
	Danger.		Indicates that this product is recyclable.
	The Battery is heavy and can cause injury if not handled safely.		Do not place near open fire or incinerate. Do not use near heaters or hot temperature sources.
	Do not submerge the battery in water or expose it to moisture or liquid.		Do not disassemble or alter the battery in any way. Do not strike or puncture the battery.
	Do not drop, deform, or impact the battery.		Do not step or put any objects onto the battery.

 <p>Keep out of reach of children, animals, and insects.</p>	 <p>Li-ion Battery.</p>
 <p>Rechargeable.</p>	 <p>Charging and Discharging.</p>
 <p>Direct Current.</p>	 <p>Product exposure.</p>
 <p>Follow the indicated temperatures.</p>	<p>BATTERY INPUT</p> <p>Battery Discharge Voltage, Battery Discharge Current, Input Voltage Type, Battery Discharge Power.</p> 
 <p>Contact the supplier within 24 hours if there is anything wrong. In case of leakage contact with eyes or skin, immediately clean with water and seek help from a doctor.</p>	 <p>Do not dispose the device, accessories, and packaging with regular waste. Follow local ordinances or contact the manufacturer for disposal guidance.</p>
 <p>The UKCA marking is used for products placed on the market in Great Britain (England, Scotland and Wales). The UKCA marking applies to most products for which the CE marking could be used.</p>	 <p>CE mark is attached to the solar inverter to verify that the unit follows the provisions of the European Low Voltage and EMC Directives.</p>

Procedures and Precautions Before Connecting

- After unpacking, please, first check the product and packing list. Please, get in touch with the local retailer if some product is damaged or lacks parts.
- Before installation, cut off the grid power and ensure the battery is in the turned-off mode.
- Wiring must be correct, do not mistake the positive and negative cables, and ensure there is no short circuit with the external device.
- It is prohibited to connect the battery and AC power directly.
- The battery system must be well grounded, and the resistance must be less than 1Ω.
- Please ensure the electrical parameters of the battery system are compatible with related equipment.
- Keep the battery away from water and fire.

Safety Precautions While Using

- Cut off the power and completely shut down the battery before moving or repairing the battery.
- Connecting the SUNSYNK-L5.3 battery with a different type of battery is prohibited.
- It is forbidden to put the batteries working with faulty or incompatible inverters.
- It is not permitted to disassemble the battery.
- Liquid fire extinguishers are forbidden. In case of fire, only dry fire extinguishers can be used.
- Please do not open, repair, or disassemble the battery except staff from SUNSYNK or authorized by SUNSYNK. We do not undertake any consequences or related responsibility because of violation of safety operation or violation of design, production, and equipment safety standards.

Handling

- The battery should only be used as instructed.
- DO NOT use the battery if it seems broken or damaged.
- The battery is non-user-serviceable and should not be opened for repair.
- Handle the battery with care when installing or transporting it.
- Chemicals should not be used to clean the battery.

Damaged Battery

A damaged battery should not be used and should be returned to Sunsynk or properly discarded via a recycling facility. Leaking electrolytes can cause skin irritation and chemical burns, so contact should be avoided.

Eye	Flush eyes with plenty of water for at least 15 minutes, occasionally lifting the upper and lower eyelids. Get medical aid.
Skin	Remove contaminated clothes and rinse skin with plenty of water or shower for 15 minutes. Get medical aid.
Inhalation	Remove from exposure and move to fresh air immediately. Use oxygen if available.
Ingestion	Give at least two glasses of milk or water. Induce vomiting unless the patient is unconscious. Call a physician.

SPECIFICATIONS AND FUNCTIONS

Dimensions and Weigh

SUNSYNK-L5.3 dimensions are presented below:

SUNSYNK-L5.3	
Depth	135mm
Width	440mm
Height	620mm
Weight	46kg

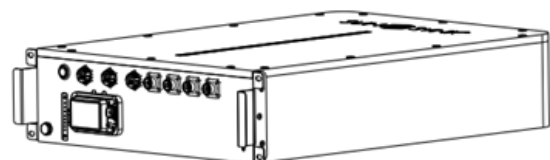
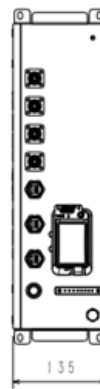
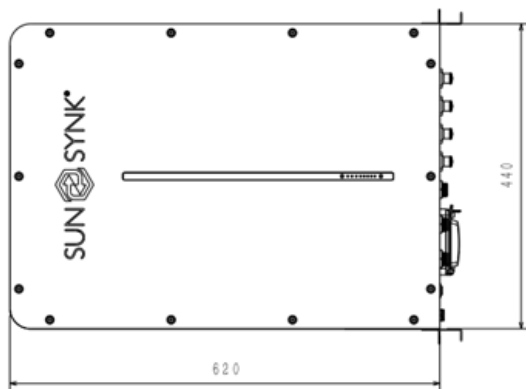

Basic System Architecture

SUNSYNK-L5.3 dimensions are presented below:

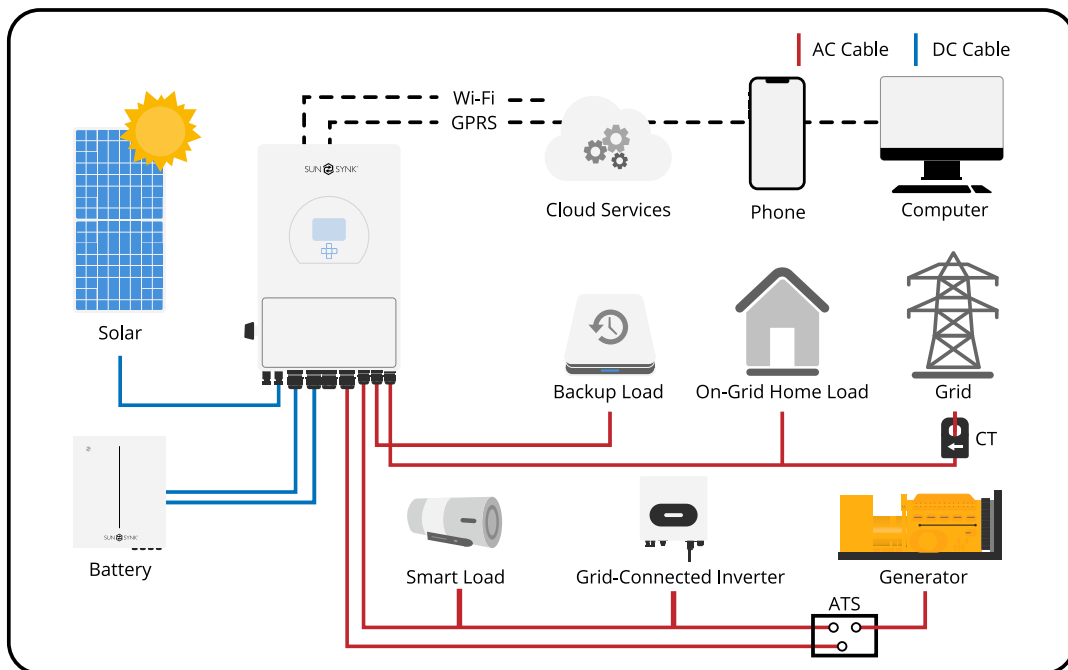

Contact our customer service or an accredited seller for precise information about application cases of the SUNSYNK-L5.3 battery.

TECHNICAL DATA

Model		SUNSYNK-L5.3
Main Parameter		
Battery Chemistry		Lithium Ferro Phosphate (LifePO4 or LFP)
Capacity		104 Ah
Scalability		Max. 32 pcs in parallel (170kWh)
Nominal Voltage		51.2 V
Operating Voltage		43.2~57.6 V
Energy		5.32 kWh
Usable Energy ^[1]		4.79 kWh
Charge/Discharge Current	Recommend ^[2]	50 A
	Max. ^[2]	100 A
	Peak (2mins,25°C)	150 A
Other Parameter		
Recommend Depth of Discharge		90%
Dimension (W/H/D)		440*620*135 mm (don't include Circuit Breaker, terminals and hanging boards)
Weight Approximate		46 kg
Master LED Indicator		5 LED (SOC 20%~100%) 3 LED (working, alarming, protecting)
IP Rating of Enclosure		IP65
Working Temperature		Charge: 0°C~+55°C (optional heating, -20°C~+55°C) Discharge: -20°C~+55°C
Storage Temperature		-20°C ~ +35°C
Humidity		5% ~ 95%
Altitude		≤2000m
Cycle Life		≥6000 (25±2°C, 90%DOD, 0.5C/0.5C, 70%EOL)
Installation		Wall Mounted (Support 19-inch standard cabinet)
Communication Port		CAN2.0, RS485
Life Cycle Power During Warranty Period ^[3]		16MWh@70%EOL
Certification		IEC62619, CE, UK, CEC, UN38.3

^[1] DC Usable Energy, test conditions: 90% DOD, 0.5C charge & discharge at 25° C. System usable energy may vary due to system configuration parameters.

^[2] The current is affected by temperature and SOC.



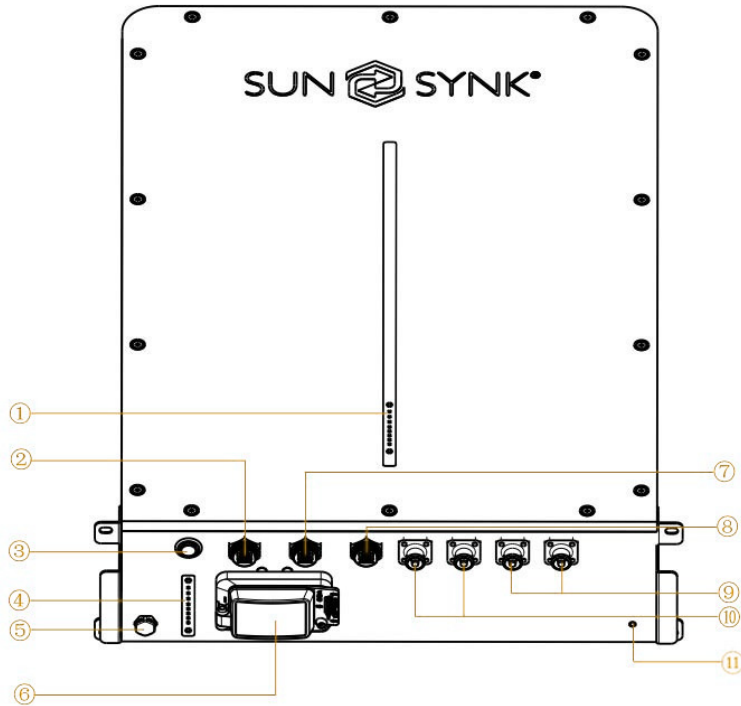

^[3] The warranty is due whichever reached first of warranty period or energy throughout.

EQUIPMENT INTERFACE INSTRUCTION

This section details the front and side panel of the interface functions. Following, you will find the SUN-SYNK-L5.3 front side illustration.



- | | |
|----------------------------|------------------------------------|
| 1. Battery Indicators | 7. Parallel Communication Port IN |
| 2. PCS | 8. Parallel Communication Port OUT |
| 3. Power Switch | 9. Battery Negative - |
| 4. Battery Indicators | 10. Battery Positive + |
| 5. Pressure Release Valve | 11. Grounding Bolt |
| 6. DC 125A Circuit Breaker | |

Interface	Symbol	Description and Instructions
Power Switch		Power Switch to turn ON/OFF the whole battery BMS standby, no power out- put.
RUN		RUN LED: 1 green LED lighting to show the battery running status, long lighting when charging and flash when discharging
Alarm		Alarm LED: 1 yellow LED lighting to show the battery has an alarm. It flash- es in alarm conditions and flashes long lighting if the equipment fails.
Error		Error LED: 1 red LED lighting to show the battery is under protection.
SOC		SOC LED: 5 green LEDs to show the battery's current capacity. Each light rep- resents 20% of the capacity.
PCS		Inverter communication terminal: (RJ45 port) follow the CAN protocol (baud rate: 500K), used to output battery information to the inverter.

Interface	Symbol	Description and Instructions
IN		Parallel Communication Terminal: (RJ45 port) Connect "out". The terminal of the Previous battery for communication between multiple parallel batteries.
OUT		Parallel Communication Terminal: (RJ45 port) Connect "IN". The terminal of the Next battery for communication between multiple parallel batteries.
DC 125A Circuit Breaker		Over current protection, cut off the power supply.
Grounding Bolt		Used for the battery connecting to the PE.

The following table presents the Led indication definition:

Condition	RUN	ALM	Error	SOC1	SOC 2	SOC 3	SOC 4	SOC 5
Power off	Off							
Charge	Blink	● Blink if Alarm Exists	Off	● Show SOC & highest LED blink				
Discharge or Idle			Off	● Show SOC & long bright				
Alarm		● Blink	Off	●				
System error/ Protect			●	Other LEDs are same as above.				
Upgrade	Blink Fast							
Critical Error	Blink Slow							

The following table presents the definition for PCS, IN, and OUT connection pins. All use the same pin number sequence shown in the next image:

Pin No.	PCS Port Definition	IN Port Definition	OUT Port Definition
1	485-B	CANL	CANL
2	485-A	CANH	CANH
3	--	DI+	DO+
4	CANH	DI-	DO-
5	CANH	DI-	DO-
6	--	DI+	DO+
7	485-A	CANH	CANH
8	485-B	CANL	CANL

Protection and Alarm	Management and Monitor
Charge/Discharge End	Intelligent Protect Mode
Charge Over Voltage	Intelligent Charge Mode
Discharge Under Voltage	Protect, Charge Current Limit
Charge/Discharge Over Current	Intelligent Protect Mode
High/Low Temperature(cell/BMS)	Intelligent Protect Mode
Short Circuit	Protect

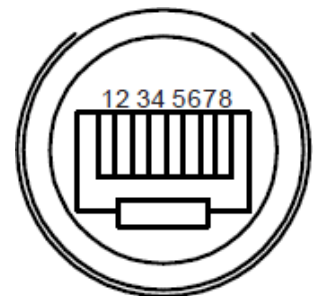

INSTALLATION

Parts List

Check if you received all the items listed below. Ensure that nothing is damaged in the package.

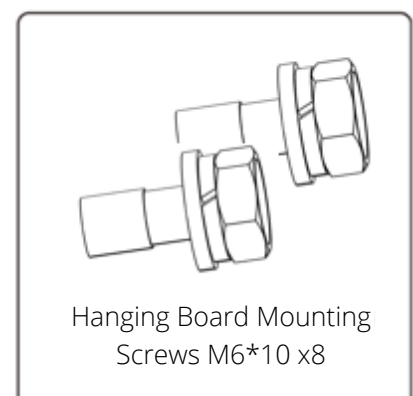
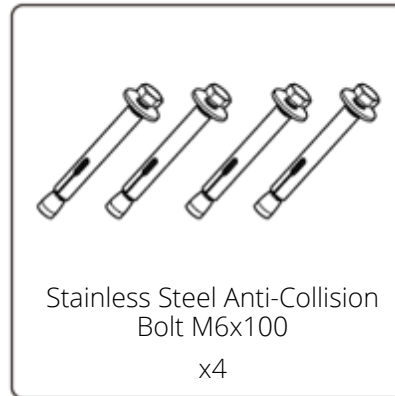
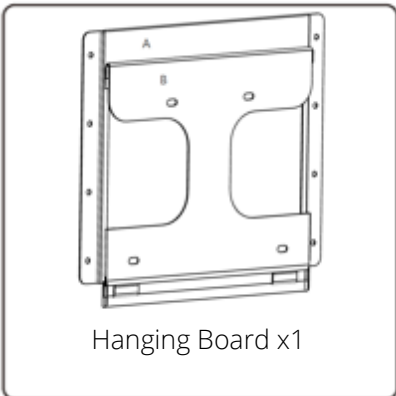
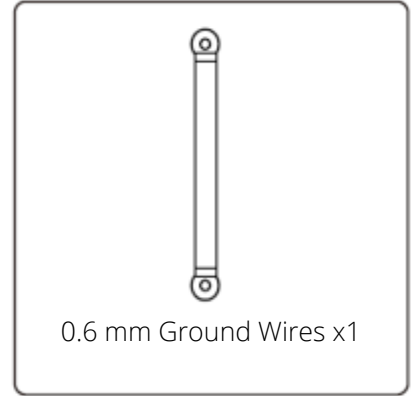
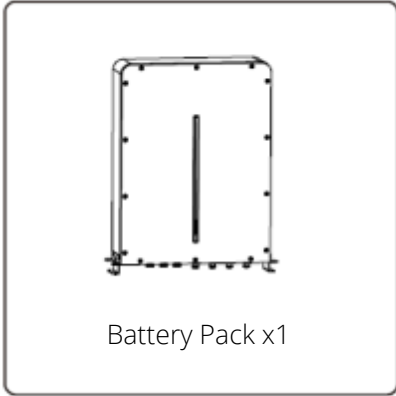

Installation Precaution

The location of the battery should follow the operating temperature range and IP rating specified in the Specification section of this manual. The SUNSYNK-L5.3 is designed for outdoor use (IP65). But please avoid direct sunlight, rain exposure, and snow laying up during installation and operation. Although the batteries run at a low temperature, proper airflow around the batteries is recommended.

When installing the set, the following conditions should be met:

- DO NOT install the product in a completely closed area with no air-conditioning. It can overheat and cause a fire.
- DO NOT place in direct sunlight or near a source of heat. This can cause deformation, a breakdown, or a fire. Pay extra attention when you place the system near windows.
- The battery must not be set where excessive oil, smoke, steam, moisture or dust is contained in the air.
- Ensure that the batteries are installed in a clean environment with minimal dust.
- Avoid installing the set near the ocean. If unavoidable, appropriate air filtration should be used to prevent salt air from in contact with the batteries.
- For proper air circulation to dissipate heat, allow a clearance of approximately 30 cm to the sides of the battery.
- DO NOT install the set near heat sources.
- DO NOT install the SUNSYNK-L5.3 in areas where highly flammable materials are stored.
- DO NOT install the SUNSYNK-L5.3 in potentially explosive areas.
- DO NOT install the SUNSYNK-L5.3 in the cool air directly.
- DO NOT install higher than an altitude of about 2000 meters above sea level.
- DO NOT install the SUNSYNK-L5.3 in an environment of precipitation or humidity (>95%).

Selecting the Mounting Area

Make sure that the installation location meets the following conditions:

- The area is entirely waterproof.
- The wall is flat and level.
- There are no flammable or explosive materials.
- The ambient temperature is within the range of -20°C to 50°C.
- The temperature and humidity are maintained at a constant level.
- There is minimal dust and dirt in the area.
- The distance from any heat sources is more than 2 meters.
- The distance from the air outlet of the inverter is more than 0.5 meters.
- Do not cover or wrap the battery case or cabinet.
- Do not place the SUNSYNK-L5.3 in the children's or pet's reach area.
- The installation area shall avoid direct sunlight.
- The battery module has no mandatory ventilation requirements, but please avoid installation in confined areas. The aeration shall avoid high salinity, humidity, or temperature.



WARNING

If the ambient temperature is outside the operating range, the battery pack stops operating to protect itself. The optimal temperature range for the battery pack is between 15°C and 35°C.

Frequent exposure to harsh temperatures may deteriorate the performance and life of the battery pack.

Tools and Safety Gears Necessary

The following tools are required to install the battery:



Torque Screwdriver



Phillips Screwdriver



Hexagon Wrench



Phillips Screwdriver



Slotted Screwdriver



Torque Wrench



Tape Measure



Driller



Pencil or Marker



WARNING

Use adequately insulated tools to prevent accidents and electric shocks or short circuits.

If insulated tools are not available, cover the entire exposed metal surfaces of the available tools, except their tips, with electrical tape.

We recommend wearing the following safety gear when dealing with the battery pack installation or maintenance.



Safety Gloves



Safety Goggles



Safety Shoes

Mounting the Battery

Fix the wall-mounted battery on the wall-mounted battery after fixing the hanging plate to the wall with stainless steel anti-collision bolts.

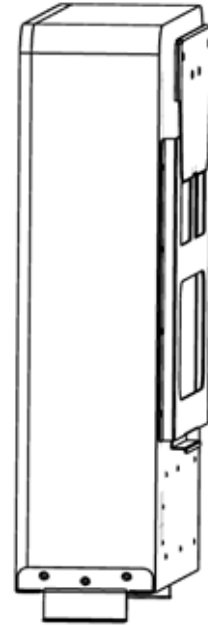
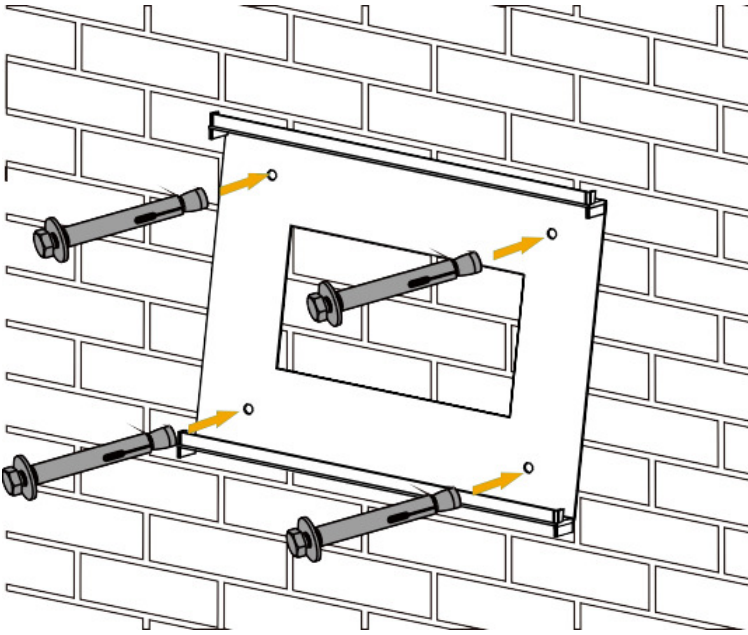

WARNING

Risk of injury (Heavy Object).

Remember that this storage system is heavy (46kg), so users must carefully handle the unit during installation, especially when mounting or removing it from the wall.

Installation

To install the SUNSYNK-L5.3 battery, follow the steps:

- Install the SUNSYNK-L5.3 battery on the wall, as shown in the previous section.
- Connect the communication cable to the inverter. The first battery communication cable should connect to the inverter for parallel installation. In contrast, the second battery should connect to the first one.

The same pattern should be used if more batteries are installed in parallel.

- Connect the power cables from the battery to the inverter terminals. **IMPORTANT**, the battery DC+ terminal should connect to the inverter DC+ terminal, and the battery DC- terminal should connect to the inverter DC- terminal. If a second battery is installed in parallel, its DC+ and DC- terminals should connect to the first battery's DC+ and DC- terminals. The same pattern should be used if more batteries are installed in parallel.
- Turn on all battery power in turn.

The following image illustrates how to connect batteries to the inverter in parallel.

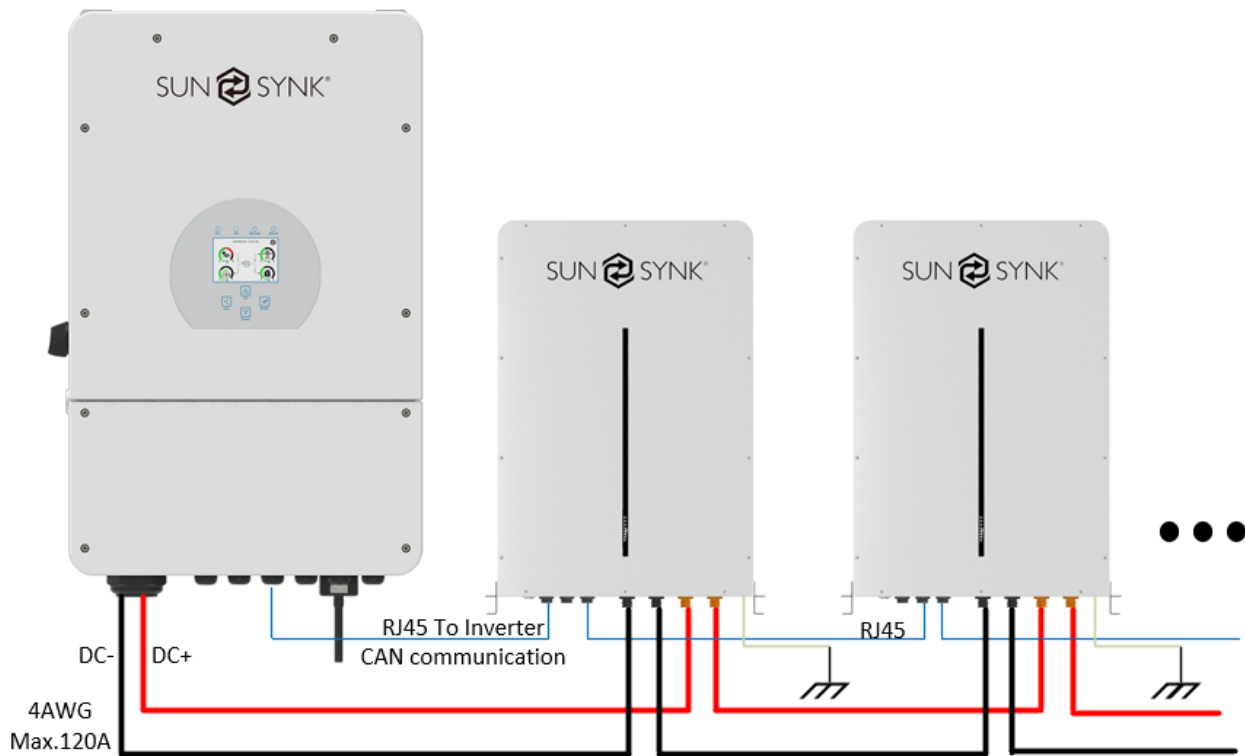

Connection Inspection

After installing and connecting the battery, check the following points:

- Usage of positive and negative cables.
- Connection of the positive and negative terminals.
- All the bolts are tightened.
- Cables fixation and appearance.
- The setting of the dialling address.
- The installation of the protecting cover.

Starting the SUNSYNK-L5.3 Battery

After completing installation, wiring, configuration, and checking all the connections, you can start the battery. Press the power button to activate the battery when the connections are correct. If the green working light on the front panel flashes, the battery system will be operating correctly.

Symbol Explanation

Many symbols are present with the battery product and used materials to install it. Next, a list of symbols and their meanings is presented.



DANGER/HIGH VOLTAGE INSIDE



CAUTION:

- Do not disassemble or alter the battery in any way.
- Do not use the battery for purposes not described in its documentation.
- Do not drop, strike, puncture, or step on the battery.
- In case of electrolyte leakage, keep leaked electrolyte away from contact with eyes or skin, immediately clean with water and seek help from a doctor.
- Do not put the battery into a fire. Do not use it or leave it in a place near fire, heaters, or high temperature sources.
- Do not submerge the battery in water, or expose it to moisture.
- Do not allow the terminals to contact exposed wire or metal.
- The battery is heavy and can cause injury if not handled safely.
- Keep out of reach of children or animals.

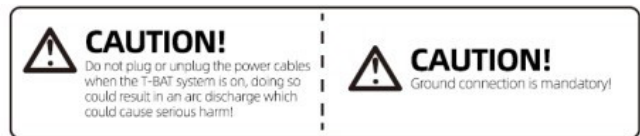

INSPECTION, CLEANING AND MAINTENANCE

General Information

- The SUNSYNK-L5.3 battery is not fully charged when shipped. We recommend installing within three months after arrival;
- During the maintenance process, do not re-install the batteries in the SUNSYNK-L5.3. Otherwise, the performance of the product will be reduced;
- It is forbidden to dismantle any battery in the SUNSYNK-L5.3, and it is not permitted to dissect the battery;
- After the SUNSYNK-L5.3 battery is over-discharged, we recommend charging the battery within 48 hours. The SUNSYNK-L5.3 can also be charged in parallel. After connecting the batteries in parallel, the charger needs to connect to the output port of any SUNSYNK-L5.3.
- Never attempt to open or dismantle the battery! The inside of the battery does not contain serviceable parts.
- Disconnect the SUNSYNK-L5.3 Li-Ion battery from all loads and charging devices before performing cleaning and maintenance activities
- Place the enclosed protective caps over the terminals before cleaning and maintenance activities to avoid the risk of contacting the terminals.

Inspection

Inspect for loose and/or damaged wiring and contacts, cracks, deformations, leakage, or damage of any other kind. If you find any damage to the battery, it must be replaced.

- Do not attempt to charge or use damaged batteries.
- **IMPORTANT:** Do not touch the liquid from a ruptured battery.

Regularly check the battery's state of charge. Lithium Iron Phosphate batteries will slowly self-discharge when not in use or whilst in storage. Consider replacing the battery with a new one if you note either of the following conditions:

- The battery run time drops below 70% of the original run time.
- The battery charge time increases significantly.

Cleaning

If necessary, clean the Li-Ion battery with a soft, dry cloth. Never use liquids, solvents, or abrasives to clean the Li-Ion battery.

Maintenance

The Li-Ion battery is maintenance-free. Charge the battery to approximately > 80% of its capacity at least once every year to preserve the battery's capacity.

Storage

The battery product should be stored in a dry and cool environment. Generally, the maximum storage period at room temperature is six months. When the battery is stored for over six months, we recommend checking the battery voltage. If the voltage exceeds 51.2V, you can continue storing the battery. In addition, you should check the voltage at least once a month until the voltage is lower than 51.2V. When the battery's voltage is lower than 51.2V, it must be charged according to the charging strategy.

The charging strategy is as follows: discharge the battery to the cut-off voltage with 0.2C (20A) current, charge with 0.2C (20A) current for about 3 hours. Keep the SOC of the battery at 40%-60% when stored. When the battery is stored, it should be kept away from explosive and flammable areas, and ignition or high-temperature sources should be kept distant from the battery.

TROUBLESHOOTING

To determine the status of the battery system, users must use additional battery status monitoring software to examine the protection mode. Refer to the installation manual about using the monitoring software. Once the user knows the protection mode, refer to the following table for solutions and additional information.

Fault Type	Fault Generation Condition	Possible Causes	Troubleshooting
BMS fault	The cell voltage sampling circuit is faulty. The cell temperature sampling circuit is faulty.	The welding point for cell voltage sampling is loose or disconnected. The voltage sampling terminal is disconnected. The fuse in the voltage sampling circuit is blown. The cell temperature sensor has failed.	Replace the battery.

Fault Type	Fault Generation Condition	Possible Causes	Troubleshooting
Electrochemical cell fault	The voltage of the cell is low or unbalanced.	Due to large self-discharge, the cell over-discharges to below 2.0V after long-term storage. External factors damage the cell, and short circuits, pin-pricks, or crushing occurs.	Replace the battery.
Over-voltage protection	The cell voltage is greater than 3.65 V in the charging state. The battery voltage is greater than 58.4 V.	The bus-bar input voltage exceeds the standard value. Cells are not consistent. The capacity of some cells deteriorates too fast, or the internal resistance of some cells is too high.	Contact local engineers to rectify the fault if the battery cannot be recovered due to protection against abnormality.
Under voltage protection	The battery voltage is less than 40V. The minimum cell voltage is less than 2.5V	The mains power failure has lasted for a long time. Cells are not consistent. The capacity of some cells deteriorates too fast, or the internal resistance of some cells is too high.	Contact local engineers to rectify the fault if the battery cannot be recovered due to protection against abnormality.
Charge or discharge high-temperature protection	The maximum cell temperature is greater than 60°C	The battery ambient temperature is too high. There are abnormal heat sources around.	Contact local engineers to rectify the fault if the battery cannot be recovered due to protection against abnormality.
Charge low-temperature protection	The minimum cell temperature is less than 0°C	The battery ambient temperature is too low.	Contact local engineers to rectify the fault if the battery cannot be recovered due to protection against abnormality.
Discharge low-temperature protection	The minimum cell temperature is less than -20°C	The battery ambient temperature is too low.	Contact local engineers to rectify the fault if the battery cannot be recovered due to protection against abnormality.

After checking the above data, please send it to our personnel service. Thus, we will evaluate your problem and reply with the best solution.

BATTERY RECOVERY

Aluminium, copper, lithium, iron, and other metal materials are recovered from discarded LiFePO₄ batteries by the advanced hydro-metallurgical process. The process can reach a recovery efficiency of up to 80%. Next, the process steps are presented.

Recovery Process and Steps of Cathode Materials

Aluminium foil as a collector is amphoteric metal. Firstly, it is dissolved in NaOH alkali solution to make aluminium enter the solution in the form of NaAlO₂. After filtration, the filtrate is neutralized with a sulphuric acid solution and precipitated to obtain Al(OH)₃. When the pH value is above 9.0, most of the aluminium precipitates, and the obtained Al(OH)₃ can reach chemical purity after analysis.

The filter residue is dissolved with sulphuric acid and hydrogen peroxide. Thus, lithium iron phosphate enters the solution in the form of Fe₂(SO₄)₃ and Li₂SO₄, separated from carbon black and carbon coated on the surface of lithium iron phosphate. After filtration and separation, the pH value of the filtrate is adjusted with NaOH and ammonia water. First, iron is precipitated with Fe(OH)₃, and the remaining solution is precipitated with saturated Na₂CO₃ solution at 90°C.

Since FePO₄ is slightly dissolved in nitric acid, the filter residue is dissolved with nitric acid and hydrogen peroxide, which directly precipitates FePO₄, separates impurities such as carbon black from the acid solution, leaches Fe(OH)₃ from filter residue respectively, and precipitates Li₂CO₃ with saturated Na₂CO₃ solution at 90°C.

Recovery of Anode Materials

The recovery process of anode materials is relatively simple. After the anode plates' separation, copper's purity can be more than 99%, which can be used to refine electrolytic copper further.

Recovery of Diaphragm

The diaphragm material is mainly harmless and has no recycling value.

List of Recycling Equipment

Automatic dismantling machine, pulverize, wet gold pool, etc.

TRANSPORTATION REQUIREMENTS

Transport the battery products just after packaging. It can be transported using cars, trains, and ships. Avoid exposing the packaging to severe vibration, impact, or extrusion during transportation. Also, avoid exposing the packaging to direct sunlight or rain.

Always check all applicable local, national, and international regulations before transporting Lithium Iron Phosphate batteries.

In some instances, transporting end-of-life, damaged, or recalled batteries may be especially limited or prohibited.

The transport of the Li-Ion batteries falls under hazard class UN3480, class 9. The battery falls within packaging group PI965 Section I for transport over water, air, or land.

Use Class 9 Miscellaneous Dangerous Goods and UN Identification labels for transportation of lithium-ion batteries, which are assigned Class 9. Refer to relevant transportation documents.

The Class 9 Miscellaneous Dangerous Goods and UN Identification Label is presented next:





CONTACT US

Email us: sales@sunsynk.com **Call us UK:** +44 151 832 4300

VAT Number: 175669460

UK Address: Sunsynk, 17 Turnstone Business Park,
Mulberry Avenue, Widnes, Cheshire, WA8 0WN.

GlobalTech Ltd

