

**TESTING FOR THE VERIFICATION OF
COMPLIANCE OF PV INVERTER WITH :
NRS 097-2-1: 2017 EDITION 2 :
GRID INTERCONNECTION OF EMBEDDED
GENERATION
PART 2: SMALL-SCALE EMBEDDED GENERATION
SECTION 1: UTILITY INTERFACE**

Test Report Number: **SHES190301262371**

Trademark: 

Tested Model.....: SUNSYNK-8K-SG01LP1

Variant Models: SUNSYNK-7.6K-SG01LP1, SUNSYNK-6K-SG01LP1, SUNSYNK-5K-SG01LP1, SUNSYNK-3.6K-SG01LP1

APPLICANT

Name: SunSynk Ltd

Address: Flat A, 3/F Wai Yip Industrial Building, 171 Wai Yip Street, Kwun Tong, Hong Kong, China.

TESTING LABORATORY

Name: SGS-CSTC Standards Technical Services (Shanghai) Co., Ltd.

Address: 588 West Jindu Road, Xinqiao, Songjiang, 201612 Shanghai, China

Conducted (tested) by: Michael Tong
(Project Engineer) 

Reviewed & Approved by: Roger Hu
(Technical Reviewer) 



Date of issue.....: **05/05/2019**

Number of pages: **86**

Important Note:

- This document is issued by the Company subject to its General Conditions of Service printed overleaf, available on request or accessible at www.sgs.com/terms_and_conditions.htm and, for electronic format documents, subject to Terms and Conditions for Electronic Documents at www.sgs.com/terms_e-document.htm. Attention is drawn to the limitation of liability, indemnification and jurisdiction issues defined therein. Any holder of this document is advised that information contained hereon reflects the Company's findings at the time of its intervention only and within the limits of Client's instructions, if any. The Company's sole responsibility is to its Client and this document does not exonerate parties to a transaction from exercising all their rights and obligations under the transaction documents.
- This document cannot be reproduced except in full, without prior written approval of the Company. Any unauthorized alteration, forgery or falsification of the content or appearance of this document is unlawful and offenders may be prosecuted to the fullest extent of the law. Unless otherwise stated the results shown in this test report refer only to the sample(s) tested.

Test Report Historical Revision:

Test Report Version	Date	Resume
SHES190301262371	05 / 05 / 2019	First issuance

INDEX

1	SCOPE	4
2	GENERAL INFORMATION	5
2.1	Testing Period and Climatic conditions	5
2.2	Equipment under Testing	5
2.3	Manufacturer and Factory information	8
2.4	Test Equipment List	8
2.5	Measurement Uncertainty	9
2.6	Test set up of the different standard	9
2.7	Definitions.....	10
3	RESUME OF TEST RESULTS	11
4	TEST RESULTS	12
4.1	Normal voltage operating range	12
4.2	Maximum short-circuit contribution	14
4.3	Flicker and voltage changes	15
4.3.1	Flicker test	15
4.3.2	Voltage change test	21
4.4	Voltage unbalance	24
4.5	Commutation notches	25
4.6	DC injection	26
4.7	Normal frequency operating range	33
4.8	Harmonic and waveform distortion.....	34
4.9	Power Factor	38
4.9.1	Test 1: PF=1	39
4.9.2	Test 2: Rectangular Curve ($Q = \pm 30\% S_n$)	41
4.9.3	Test 3: Triangular Curve ($PF = \pm 0.8$)	49
4.9.4	Test 4: Semicircular Curve ($S = 100\% S_n$)	53
4.9.5	Test 5: Settable to operate according to a characteristic curve	57
4.10	Synchronization and Response to utility recovery	59
4.11	Electromagnetic compatibility (EMC)	62
4.12	Mains signalling (e.g. PLC and ripple control)	62
4.13	Safety disconnect from utility network.....	62
4.13.1	Disconnection device (previously disconnection switching unit).....	62
4.13.2	Overvoltage and undervoltage	63
4.13.3	Overfrequency and underfrequency	69
4.14	Prevention of islanding	74
4.15	Isolation	76
4.16	Earthing	76
4.17	Labelling.....	76
4.18	Robustness requirements	76
5	PICTURES	77
6	ELECTRICAL SCHEMES	86

1 SCOPE

SGS-CSTC Standards Technical Services (Shanghai) Co., Ltd. has been contracted by SunSynk Ltd, in order to perform the testing according to the standard:

- NRS 097-2-1: 2017 Edition 2: Grid Interconnection of Embedded Generation
PART 2: Small-Scale Embedded Generation
SECTION 1: Utility Interface

2 GENERAL INFORMATION

2.1 Testing Period and Climatic conditions

The necessary testing has been performed along 15 working days between the 3rd of April and the 27th of April of 2019.

All the tests and checks have been performed in accordance with the reference Standard (the tests are done at 25 ± 5°C, 96 kPa ± 10 kPa and 45% RH ± 10% RH).

SITE TEST

Name : Shenzhen BALUN Technology Co., Ltd.
 Address : Block B, 1st FL, Baisha Science and Technology Park, Shahe Xi Road, Nanshan District, Shenzhen, Guangdong Province. P.R. China

2.2 Equipment under Testing

Apparatus type : **Hybrid Inverter**
 Installation : Fixed(permanent connection)
 Manufacturer : **SunSynk Ltd**
 Trade mark :



Type..... : **SUNSYNK**
 Model / Type reference : **SUNSYNK-8K-SG01LP1**
 Serial Number : 1810254025 SD
 Software Version : COMM:0250
 MCU: Ver1585
 Rated Characteristics : Refer to page 7
 Date of manufacturing: 2018

Input..... : DC
 Output..... : AC
 Class of protection against electric shock... : Class I
 Degree of protection against moisture : IP 20 / IP 65
 Type of connection to the main supply..... : TN
 Cooling group : Heat sink and Fan
 Modular : No
 Internal Transformer..... : No

Equipment under testing:

- **SUNSYNK-8K-SG01LP1**

The variants models are:

- **SUNSYNK-7.6K-SG01LP1**
- **SUNSYNK-6K-SG01LP1**
- **SUNSYNK-5K-SG01LP1**
- **SUNSYNK-3.6K-SG01LP1**

Model Number	SUNSYNK-8K-SG01LP1	SUNSYNK-7.6K-SG01LP1	SUNSYNK-6K-SG01LP1	SUNSYNK-5K-SG01LP1	SUNSYNK-3.6K-SG01LP1
Max. input power	8800w	8360w	6600w	5500w	3960W
Max. input voltage	500Vd.c.				
Max. input current	18Ad.c.*2	18Ad.c.*2	20Ad.c.+10Ad.c.	10Ad.c.*2	10Ad.c.*2
MPPT voltage range	150-425Vd.c.				
Battery type	Lead-acid battery or lithium –ion battery				
Battery voltage(V)	48Vdc				
Max.Charger and Discharger power(W)	8800w	8360w	6600w	5500w	3960W
Rated grid voltage	230Vac				
Rated grid frequency	50Hz				
Rated output power	8000w	7600w	6000w	5000w	3600w
Rated output current	38.5Aa.c	33.5Aa.c	26.1Aa.c	20.8Aa.c	15.7 Aa.c
Power factor	0.9 leading to 0.9 lagging				
Ambient temperature	-25°C~60°C(> 45°C derating)				
Ingress protection	IP20/IP65	IP20/IP65	IP65	IP65	IP65
Protective class	Class I				

The variants models have been included in this test report without tests because the following features don't change regarding to the tested model:

- Same connection system and hardware topology
- Same control algorithm.
- Output power within 2.5 and 2/3 of the EUT or Modular inverters.
- Same Firmware Version

The results obtained apply only to the particular sample tested that is the subject of the present test report. The most unfavorable result values of the verifications and tests performed are contained herein.

Throughout this report a point (comma) is used as the decimal separator.

2.3 Manufacturer and Factory information

Manufacturer Name..... : SunSynk Ltd
 Manufacturer Address : Flat A, 3/F Wai Yip Industrial Building, 171 Wai Yip Street, Kwun Tong, Hong Kong, China.
 Factory Name..... : NingBo Deye Inverter Technology Co., Ltd.
 Factory Address : No.26 South YongJiang Road, Daqi, Beilun, NingBo, China.

2.4 Test Equipment List

From	No.	Equipment Name	MARK/Model No.	Equipment No.	Equipment calibration due date
Balun	1	Current clamp	CT6863-05	BZ-EP-L006	2020/2/27
	2	Current clamp	CT6863-05	BZ-EP-L007	2020/2/27
	3	Current clamp	CT6863-05	BZ-EP-L008	2020/2/27
	4	Differential probe	DP6130	BZ-SFT-L061	2019/11/4
	5	Temperature & Humidity meter	DT-322	BZ-DGD-L005	2020/3/8
	6	Power analyzer	PW6001-16	BZ-EP-L005	2020/2/26
	8	Digital oscilloscope	MS04054B	BZ-EP-L016	2020/2/25
	9	Temperature & Humidity Chamber	8m3	BZ-KKX-L018	2019/11/1
	10	Current clamp	CT6863-05	BZ-EP-L006	2020/2/27
	11	Current clamp	CT6863-05	BZ-EP-L006	2020/2/27
	12	Temperature & Humidity meter	DT-322	BZ-DGD-L005	2020/3/8
	SGS	12	True RMS Multimeter	Fluke / 289C	GZE012-53

2.5 Measurement Uncertainty

Associated uncertainties through measurements showed in this this report are the maximum allowable uncertainties.

Magnitude	Uncertainty
Voltage measurement	±1.5 %
Current measurement	±2.0 %
Frequency measurement	±0.2 %
Time measurement	±0.2 %
Power measurement	±2.5 %
Phase Angle	±1°
Temperature	±3° C

Note1: Measurements uncertainties showed in this table are maximum allowable uncertainties. The measurement uncertainties associated with other parameters measured during the tests are in the laboratory at disposal of the petitioner.

Note2: Where the standard requires lower uncertainties that those in this table. Most restrictive uncertainty has been considered.

2.6 Test set up of the different standard

Below is the simplified construction of the test set up.

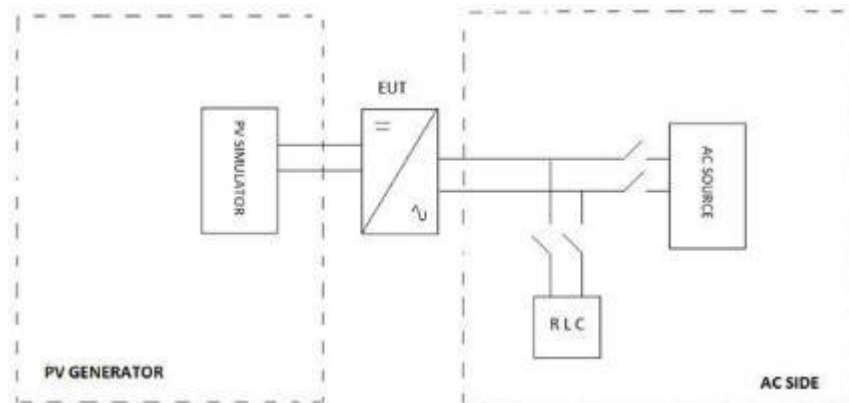

Different equipment has been used to take measures as it shows in chapter 2.3. Current and voltage clamps have been connected to the inverter input / output for all the tests. All the tests described in the following pages have used this specified test setup.

The test bench used includes:

No.	Equipment Name	MARK/Model No.	Equipment No.
1	AC source	Parwa / PVS7030T	16100790
2	PV array simulator	Chroma 62150H-1000S	BZ-EP-L002
3	RLC load	ACLT-38160H	BZ-DGD-L003

2.7 Definitions

In	Nominal Current	P	Power
p.u	Per unit	I	Current
Pn	Nominal Power	M	Change for real power
Sn	Apparent Power	N	Change for reactive power
PGU	Power Generation Unit	F	Frequency
Pst	Short-term flicker strength	Q _f	Quality factor
Plt	Long-term flicker strength	NS	Network and System
C _{ψK}	Flicker coefficient for continuous operation	Un	Nominal Voltage
S _r	Apparent Power Rated	PWHD	Partial weight harmonic distortion
S _k	Short-circuit Apparent Power	THD	Total harmonic distortion
K _{imax}	Maximum switching current factor	Z _{test}	Test circuit impedance at which the emission test
Z _{ref}	The reference impedance	EUT	Equipment under test
a.c.	alternating current	d.c.	direct current
EG	embedded generator	I _{SC}	short-circuit current
PCC	point of common coupling	POC	point of connection
PV	photovoltaic	QOS	quality of suppl

3 RESUME OF TEST RESULTS

INTERPRETATION KEYS

- Test object does meet the requirement **P** Pass
- Test object does not meet the requirement **F** Fails
- Test case does not apply to the test object **N/A** Not applicable
- To make a reference to a table or an annex..... See additional sheet
- To indicate that the test has not been realized..... **N/R** Not realized

CHAPTER OF THE STANDARD, DESCRIPTION AND VERIFICATION			
4	Requirements		
4.1	Utility compatibility (Performance aspects)		P
4.1.1	General		--
4.1.2	Normal voltage operating range		P
4.1.3	Reference source impedance and short-circuit levels (fault levels)		P
4.1.4	General QOS requirements		N/A
4.1.5	Flicker and voltage changes		P
4.1.6	Voltage unbalance		N/A
4.1.7	Commutation notches		P
4.1.8	DC injection		P
4.1.9	Normal frequency operating range		P
4.1.10	Harmonics and waveform distortion		P
4.1.11	Power factor		P
4.1.12	Synchronization		P
4.1.13	Electromagnetic compatibility (EMC)		P
4.1.14	Mains signalling (e.g. PLC and ripple control)		N/A
4.2	Safety protection and control		P
4.2.1	General		--
4.2.2	Safety disconnect from utility network		P
4.2.3	Emergency personnel safety		N/A
4.2.4	Response to utility recovery		P
4.2.5	Isolation		P
4.2.6	Earthing		P
4.2.7	Short-circuit protection		P
4.2.8	Maximum short-circuit contribution		P
4.2.9	Labelling		P
4.2.10	Robustness requirements		P
4.3	Metering		N/A

4 TEST RESULTS

4.1 NORMAL VOLTAGE OPERATING RANGE

Normal voltage operating range tests have been measured according to Clause 4.1.2 of the standard.

In accordance with IEC 61727, utility-interconnected embedded generators do not normally regulate voltage, they inject current into the utility. Therefore, the voltage operating range for embedded generators is designed as protection which responds to abnormal utility network conditions and not as a voltage regulation function.

The results are offered in the table below:

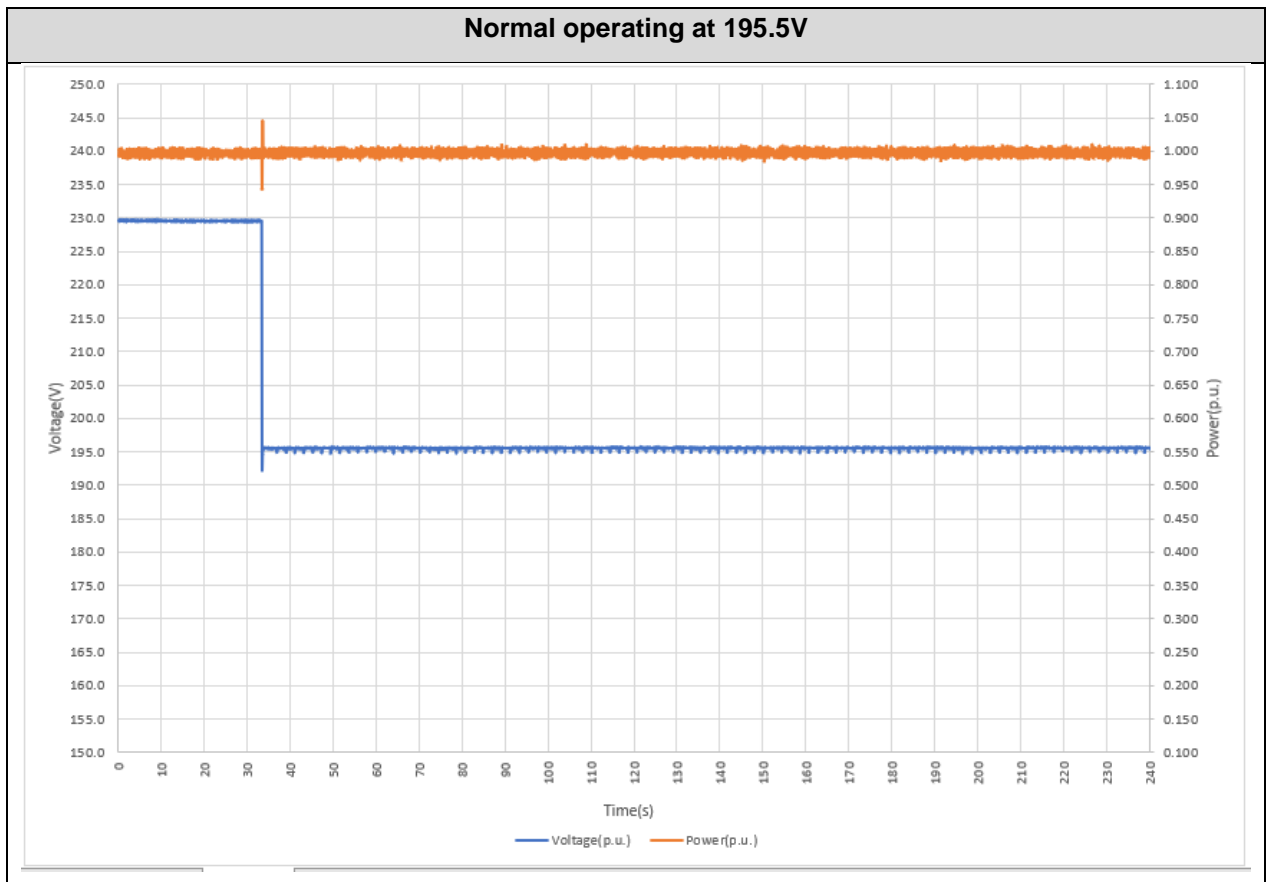

Normal operating at 253V

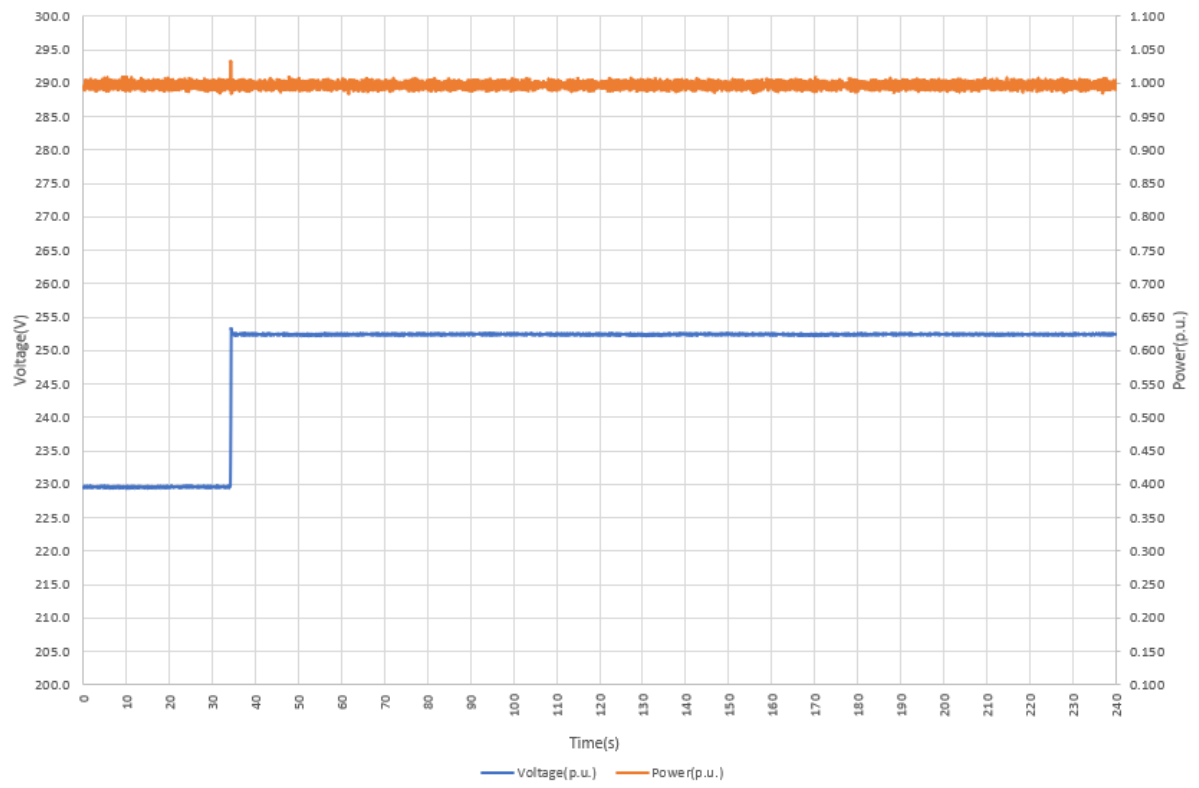

4.2 MAXIMUM SHORT-CIRCUIT CONTRIBUTION

Maximum Short-circuit tests have been measured according to Clause 4.1.3, Clause 4.2.7 and 4.2.8 of the standard.

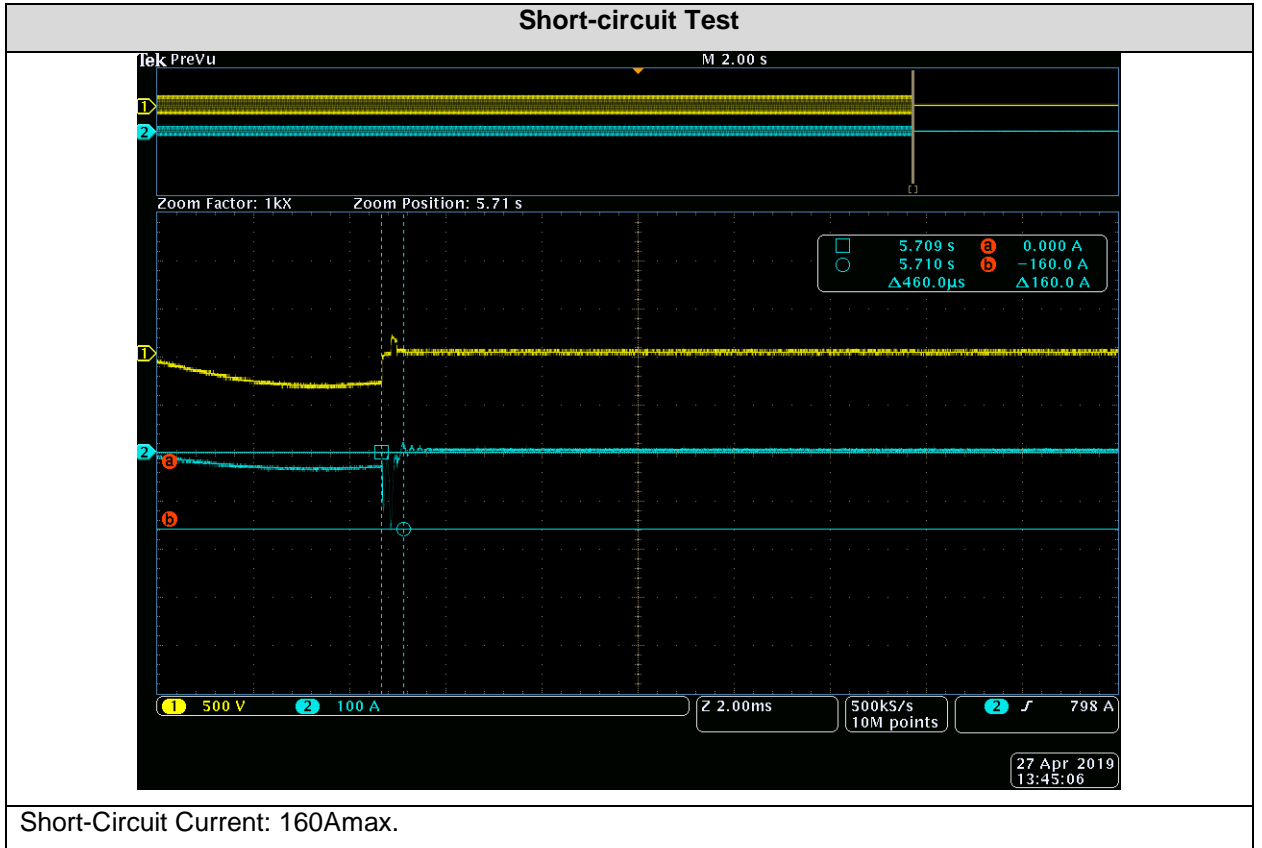

Note: network strength: $Z_{source} = 1.05 + j 0.32 \text{ ohm}$, i.e. $I_{SC} = 210 \text{ A}$

4.3 FLICKER AND VOLTAGE CHANGES

Flicker and voltage tests have been measured according to Clause 4.1.5 of the standard.

4.3.1 Flicker test

The flicker test result as following:

P _n (%)	Limit	5 %	15 %	25%	33 %	45%
PST	≤ 0.35	0.08	0.09	0.07	0.08	0.08
PLT	≤ 0.30	0.08	0.08	0.07	0.08	0.08

P _n (%)	Limit	55 %	66 %	75%	85%	100%
PST	≤ 0.35	0.08	0.10	0.08	0.08	0.07
PLT	≤ 0.30	0.08	0.11	0.08	0.08	0.07

As it can be seen in the next screenshots, this test has 12 steps. The values took of Pst, Plt, dc and dmax are the most unfavorable of the 12 steps.

Network strength: Z_{source} = 1.05 + j 0.32 ohm

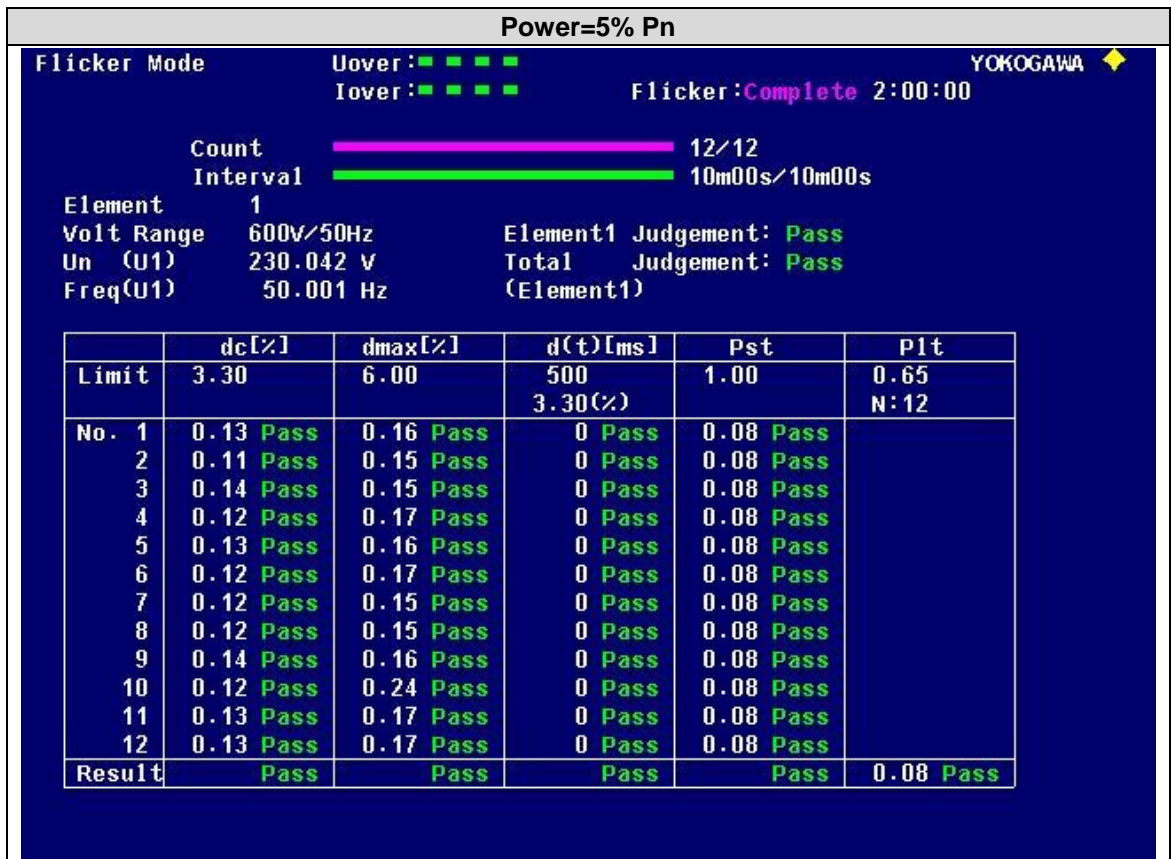

NRS 097-2-1: 2017 Edition 2

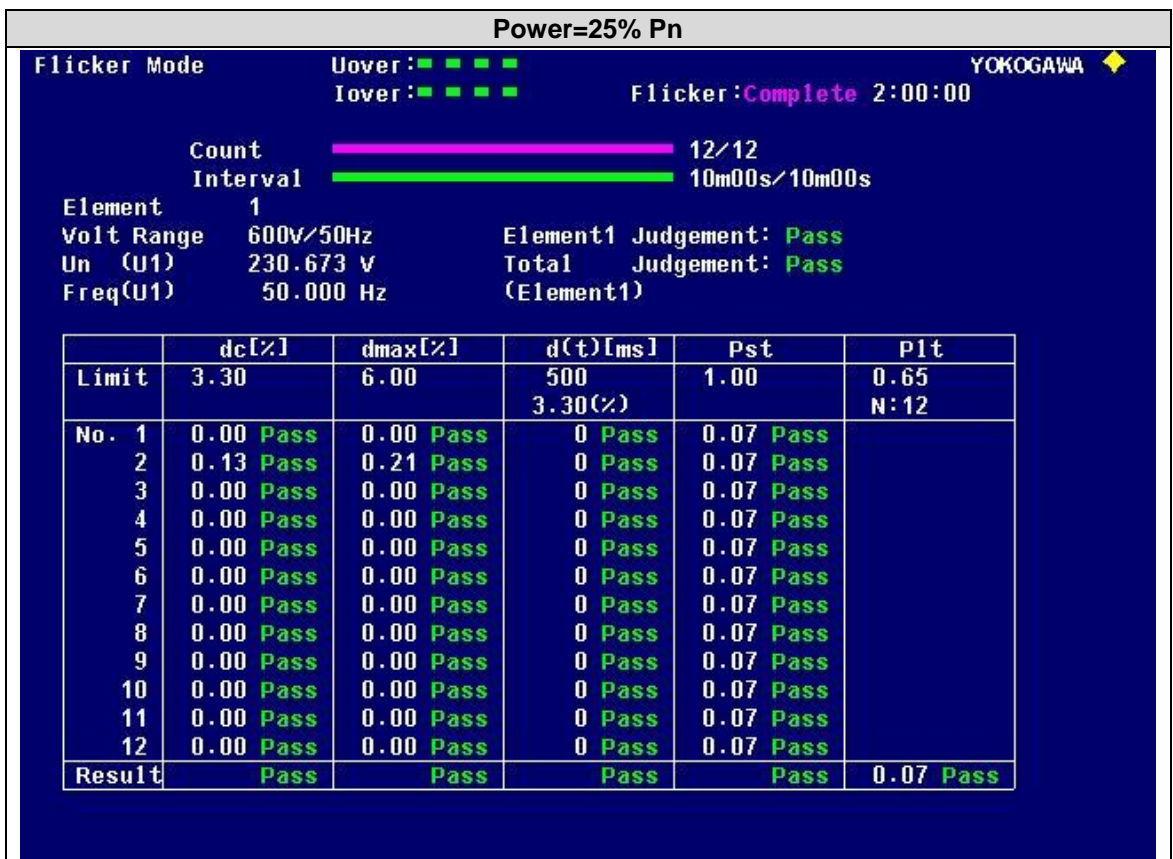
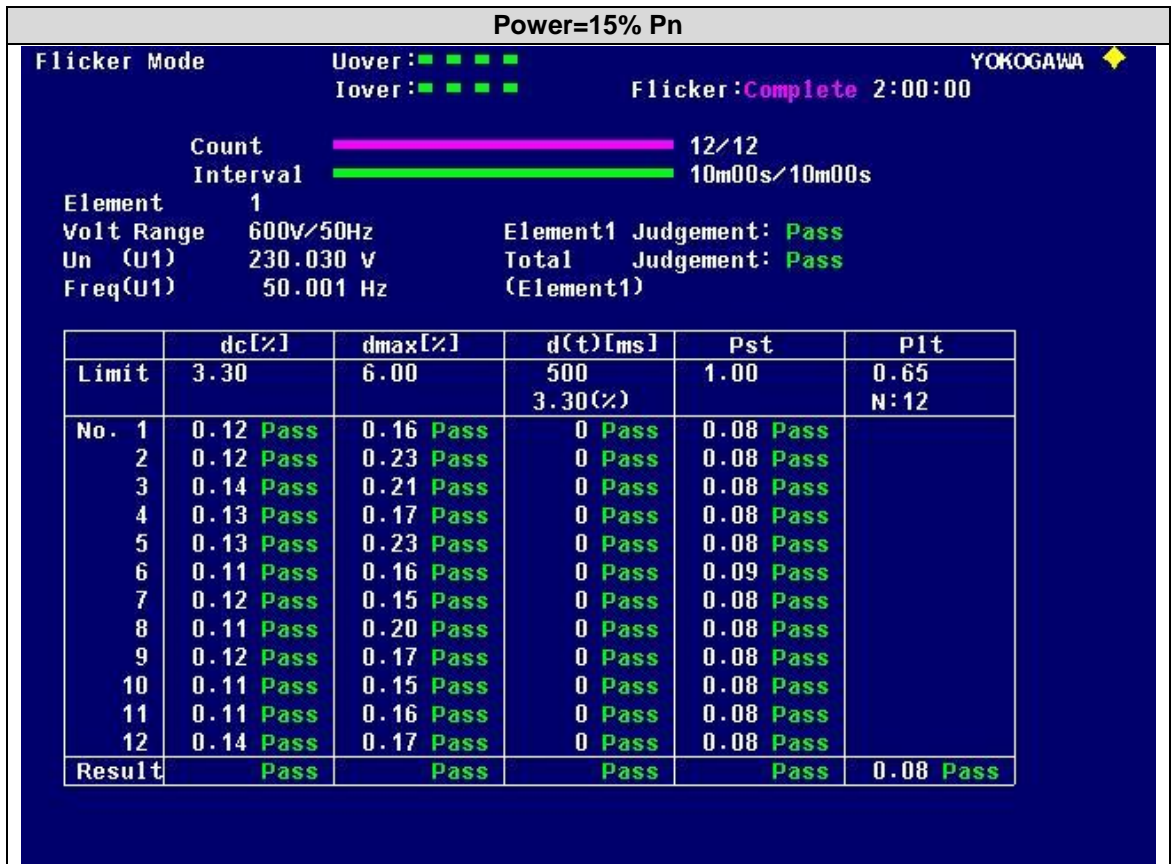

NRS 097-2-1: 2017 Edition 2

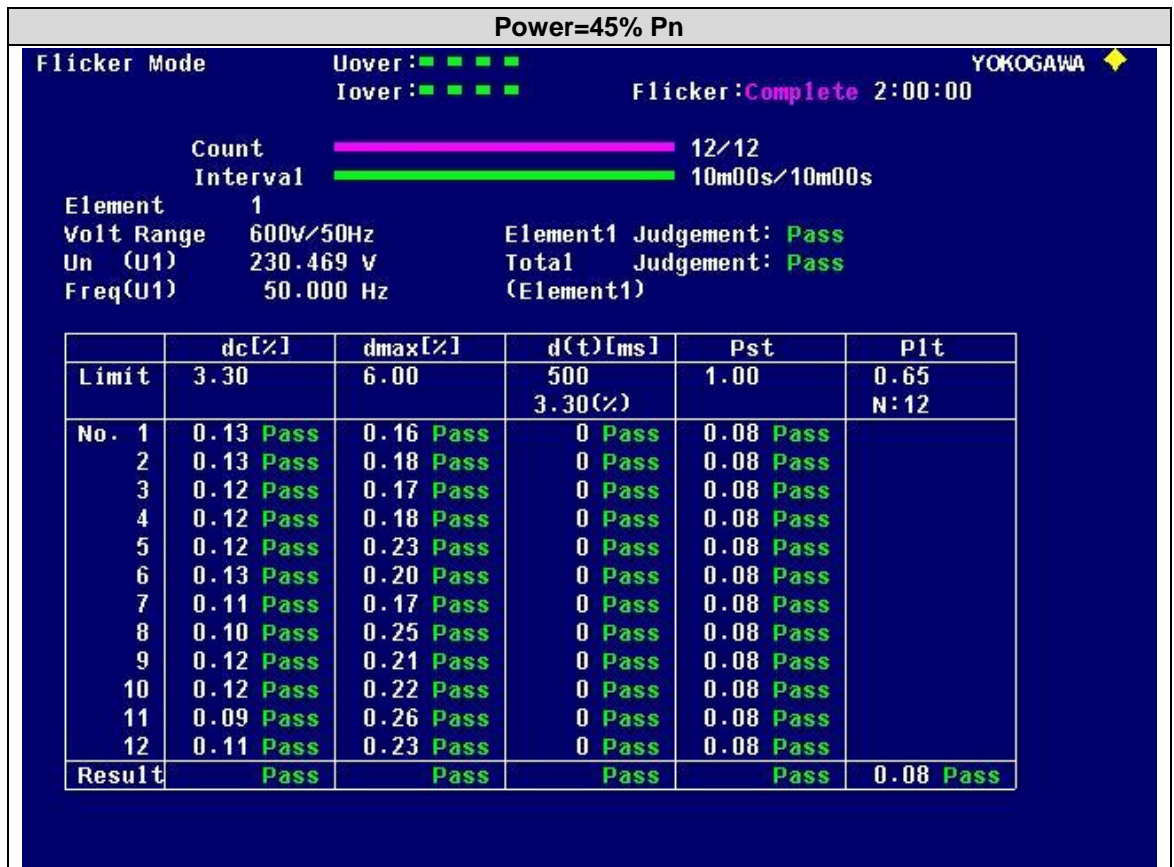
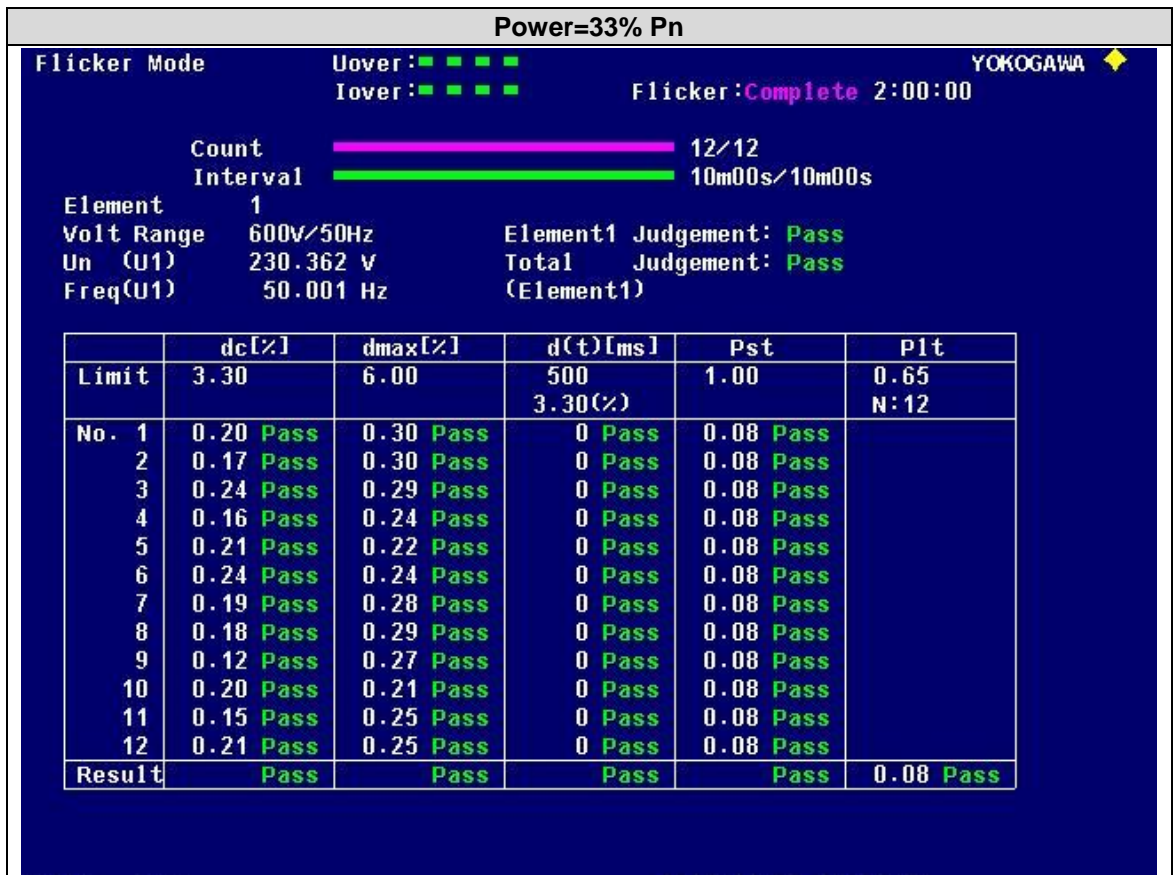

NRS 097-2-1: 2017 Edition 2

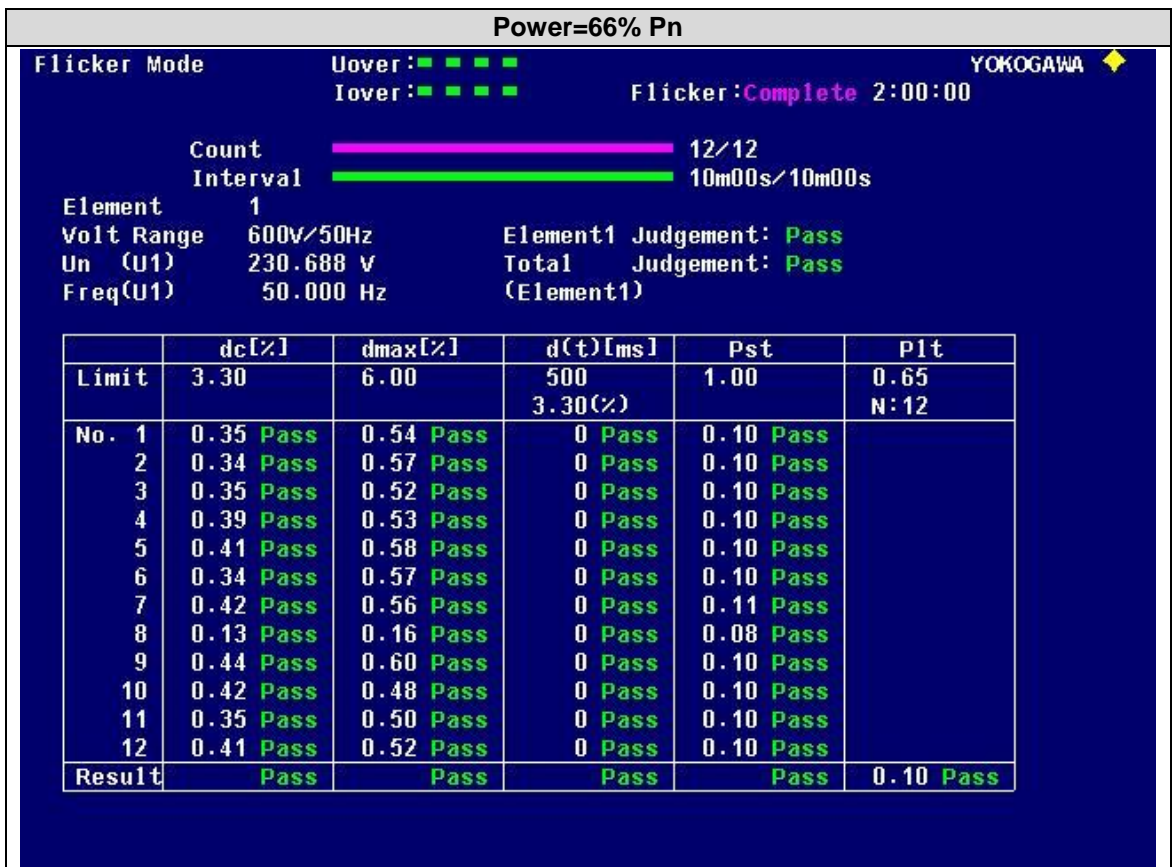
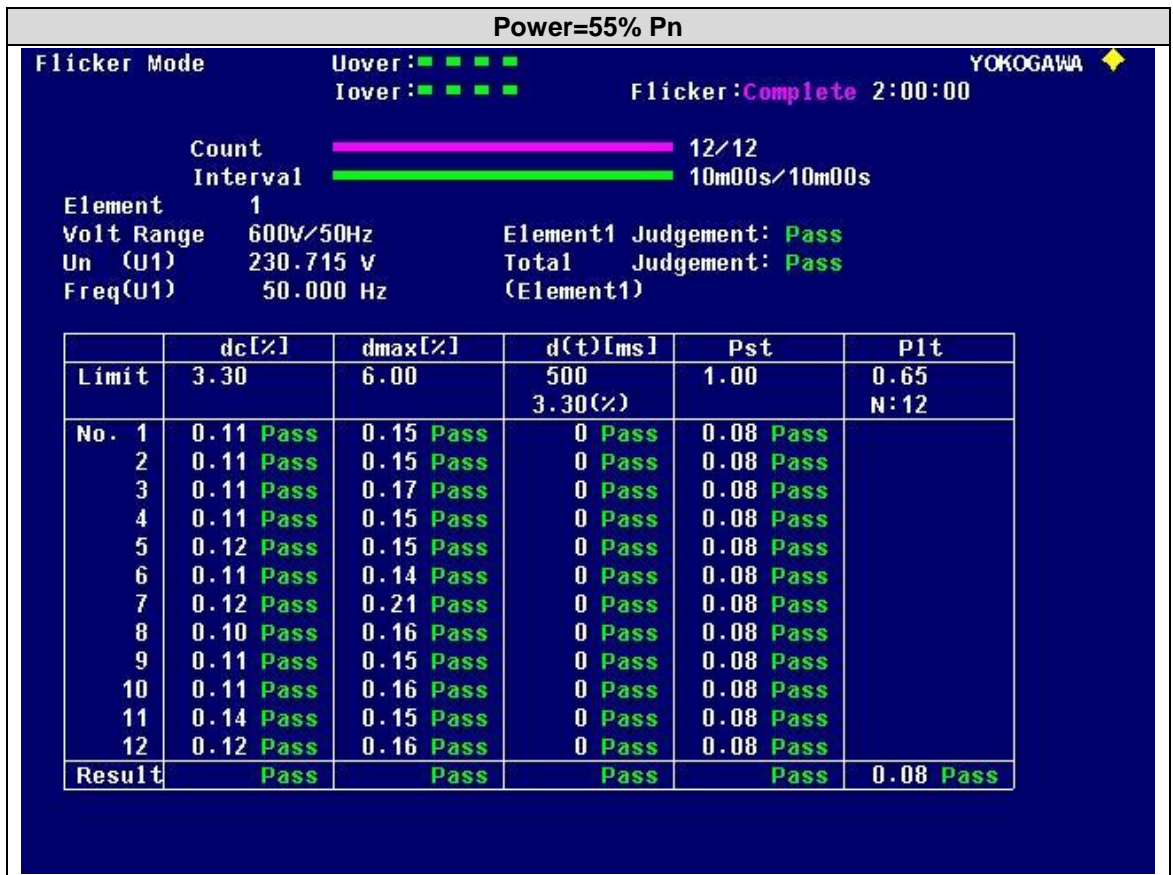

NRS 097-2-1: 2017 Edition 2

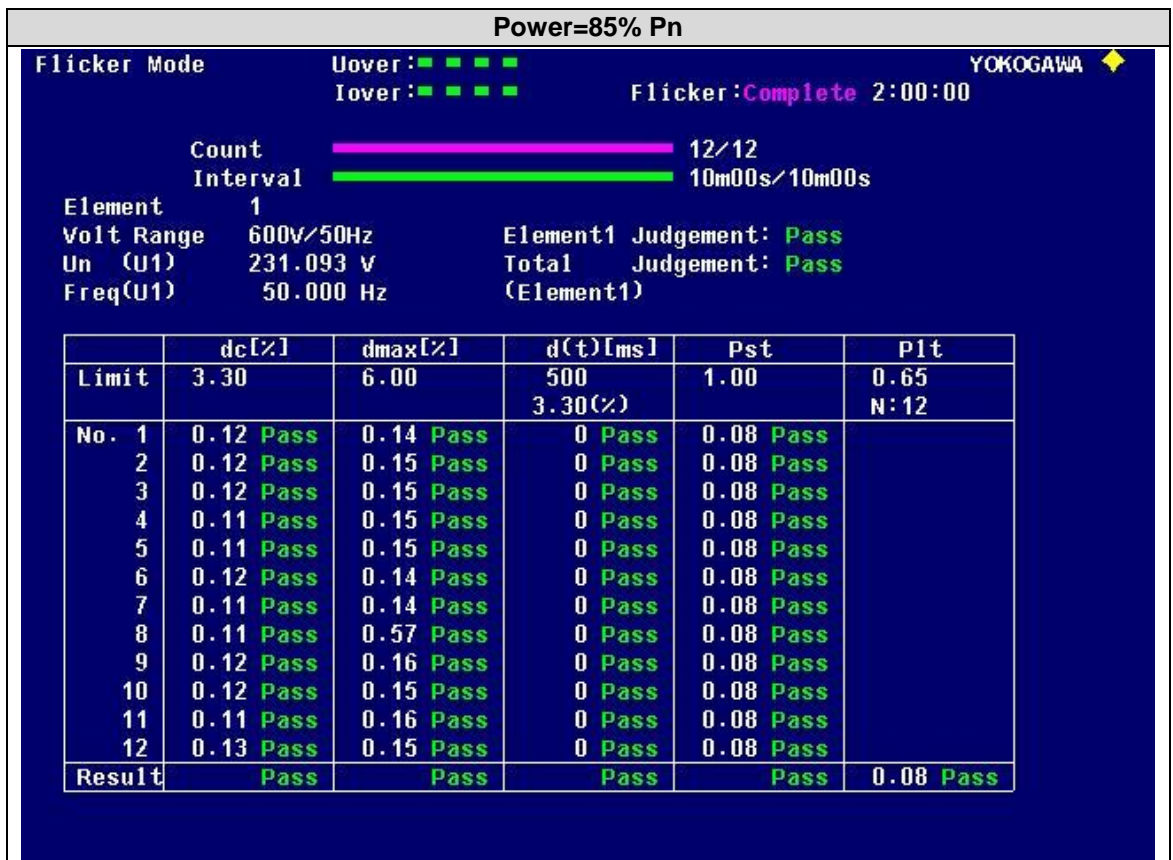
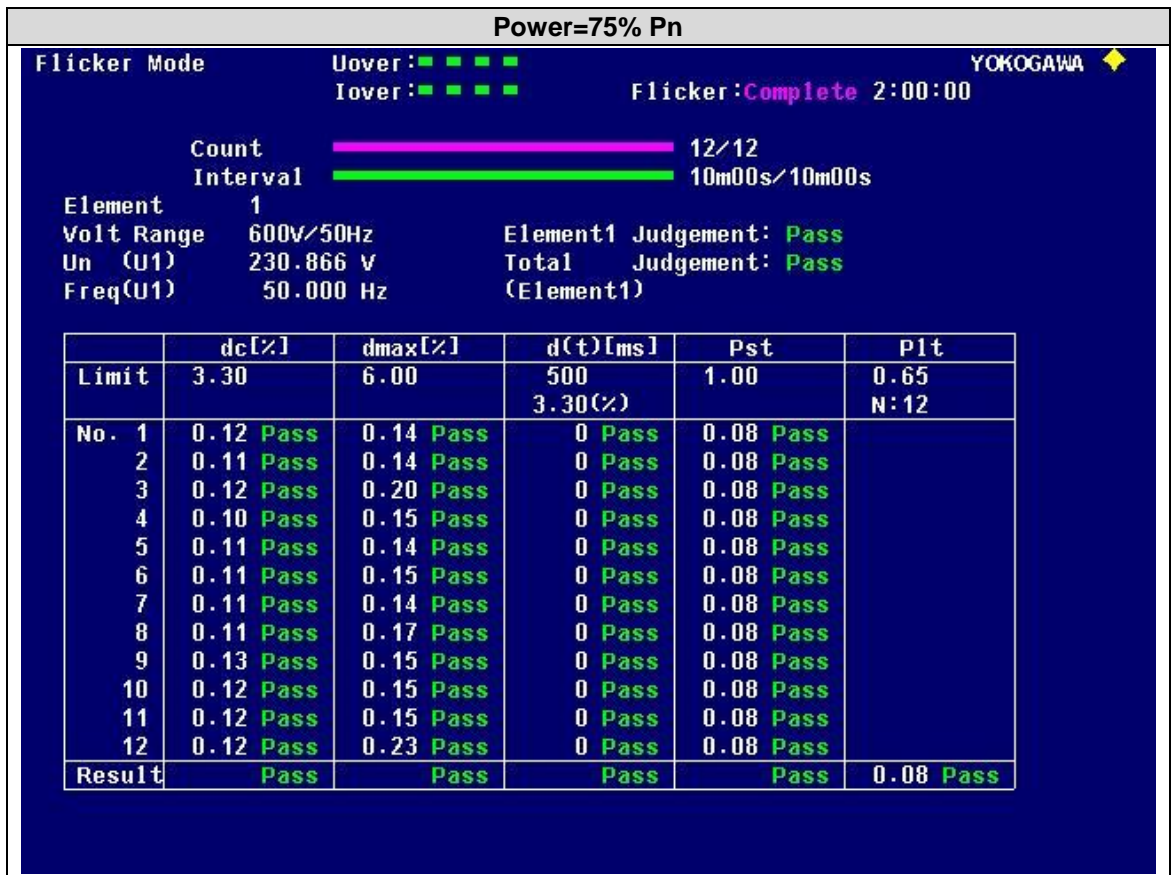

NRS 097-2-1: 2017 Edition 2

Power=100% Pn

Flicker Mode Uover: ■ ■ ■ ■ YOKOGAWA ◆
 Iover: ■ ■ ■ ■ Flicker: Complete 2:00:00

Count ████████████████████ 12/12
 Interval ████████████████████ 10m00s/10m00s

Element 1
 Volt Range 600V/50Hz Element1 Judgement: Pass
 Un (U1) 231.360 V Total Judgement: Pass
 Freq(U1) 49.999 Hz (Element1)

	dc[%]	dmax[%]	d(t)[ms]	Pst	P1t
Limit	3.30	6.00	500 3.30(%)	1.00	0.65 N:12
No. 1	0.13 Pass	0.15 Pass	0 Pass	0.08 Pass	
2	0.11 Pass	0.21 Pass	0 Pass	0.08 Pass	
3	0.11 Pass	0.15 Pass	0 Pass	0.08 Pass	
4	0.10 Pass	0.18 Pass	0 Pass	0.08 Pass	
5	0.10 Pass	0.22 Pass	0 Pass	0.08 Pass	
6	0.10 Pass	0.19 Pass	0 Pass	0.08 Pass	
7	0.10 Pass	0.23 Pass	0 Pass	0.08 Pass	
8	0.10 Pass	0.21 Pass	0 Pass	0.08 Pass	
9	0.10 Pass	0.24 Pass	0 Pass	0.08 Pass	
10	0.09 Pass	0.20 Pass	0 Pass	0.08 Pass	
11	0.10 Pass	0.23 Pass	0 Pass	0.08 Pass	
12	0.10 Pass	0.22 Pass	0 Pass	0.08 Pass	
Result	Pass	Pass	Pass	Pass	0.08 Pass

4.3.2 Voltage change test

The rapid voltage changes test has been measured according to the paragraph 5.4.2 of VDE-AR-N 4105: 2011-08 and the paragraph 5.1.2 of VDE V 0124-100:2012-07, at the required conditions. The maximum voltage change does not exceed a value of 3%U_{max} and it is calculated as follows:

$$\Delta U_{max} \leq 3\%$$

$$\Delta U_{max} = k \times \frac{S_{emax}}{S_{kv}}$$

- S_{emax} is the maximum apparent power of inverter.
- S_{kv} is the network short circuit power.
- K=0.5 (for synchronous generators with fine synchronization, inverters)

In the tested equipment, the value of S_{kv} is much greater than the value of S_{emax}, so S_{emax}/S_{kv} will be approximately 0, so ΔU_{max}≈0.

According to the performed tests, the S_{kv} minimum for with the inverter can be installed is 270 kW.

The information provided above should be taken into account for the particular conditions of the installation of the inverter.

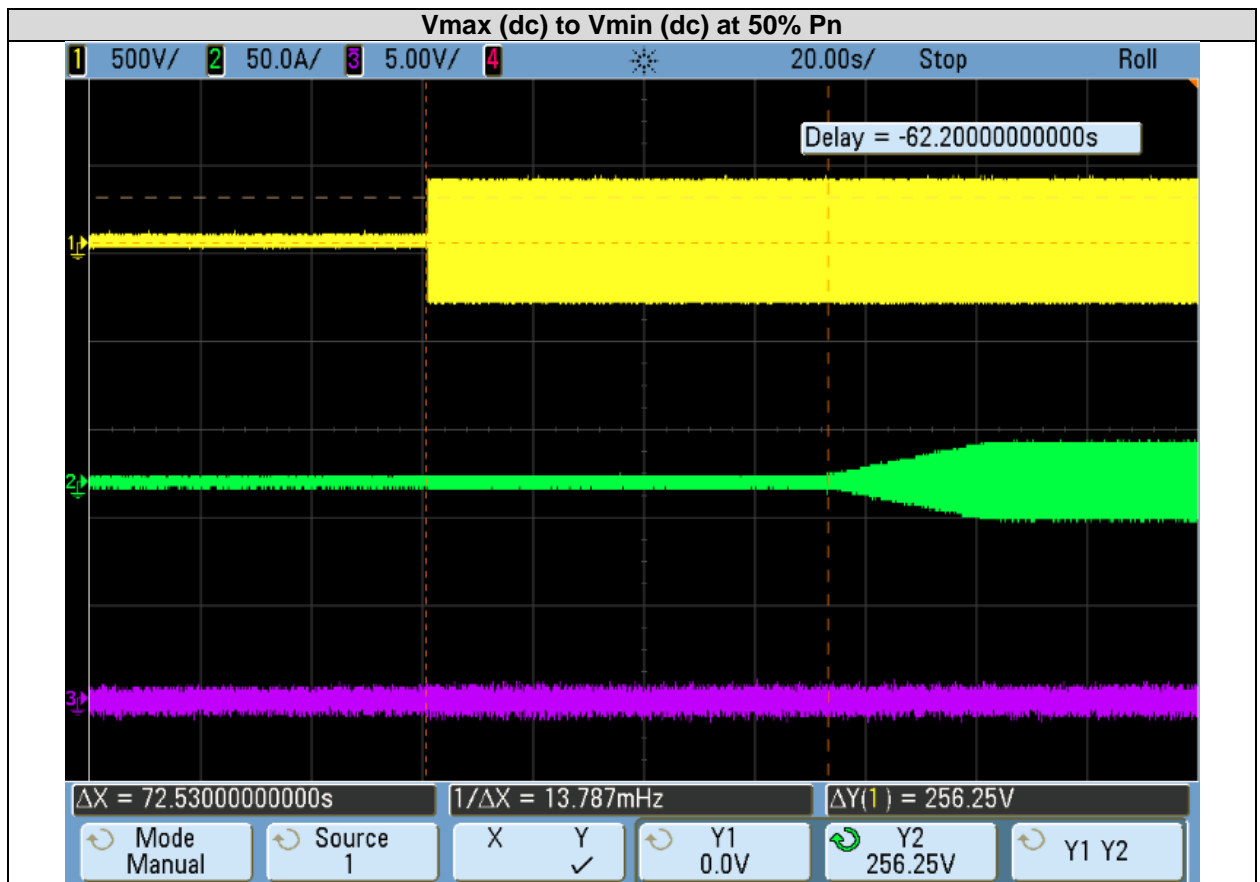

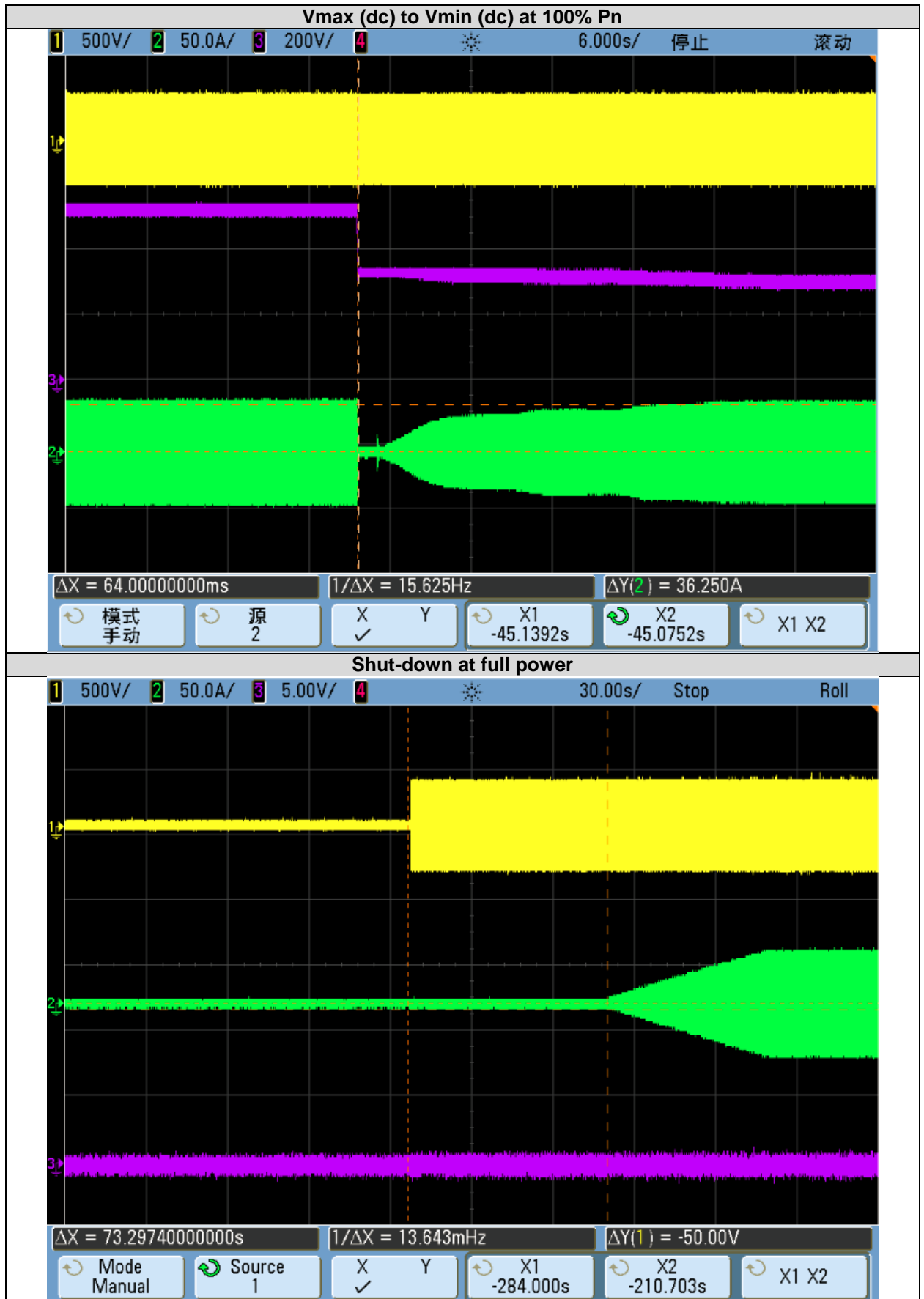

NRS 097-2-1: 2017 Edition 2



4.4 VOLTAGE UNBALANCE

Voltage unbalance have been measured according to Clause 4.1.6 of the standard. In this case is not applicable due to the single-phase inverters does not use for uniform distribution of the power supplied to the three line conductors

4.5 COMMUTATION NOTCHES

The commutation notches test has been measured according to Clause 4.1.7 of the standard. The standard requires a maximum relative depth of commutation notches, d_{kom} , of 5 % of nominal voltage at the POC for any operational state.

By the next picture it is obtained that the inverter start connects to PCC.

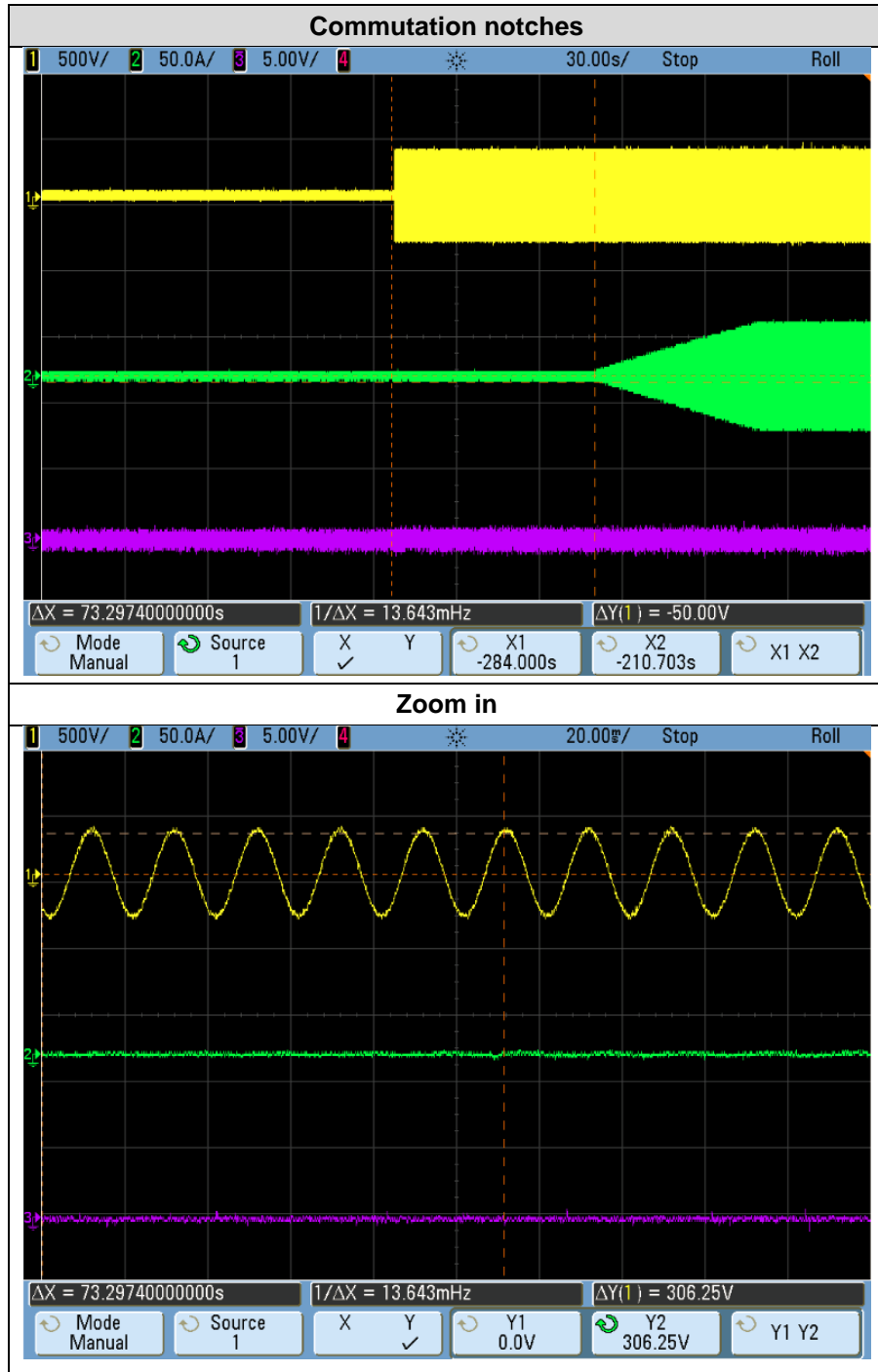

For this frequency of commutation, it is measured that the product has a relative depth of commutation of 0.9417 %.

4.6 DC INJECTION

DC injection test has been measured according to Clause 4.1.8 and Clause 4.2.2.5 of the standard.

The embedded generator shall not inject d.c. current greater than 0.5 % of the rated a.c. output current into the utility interface under any operating condition, measured over a 1-minute interval. The EG shall cease to energize the utility network within 500 ms if this threshold is exceeded.

Measured d.c. current						
Power Bin	10%Pn	20%Pn	30%Pn	40%Pn	50%Pn	Limited
d.c. current measured result (mA) (max. value)	80	76	90	96	122	192.5
Power Bin	60%Pn	70%Pn	80%Pn	90%Pn	100%Pn	Limited
d.c. current measured result (mA) (max. value)	113	111	118	161	104	192.5

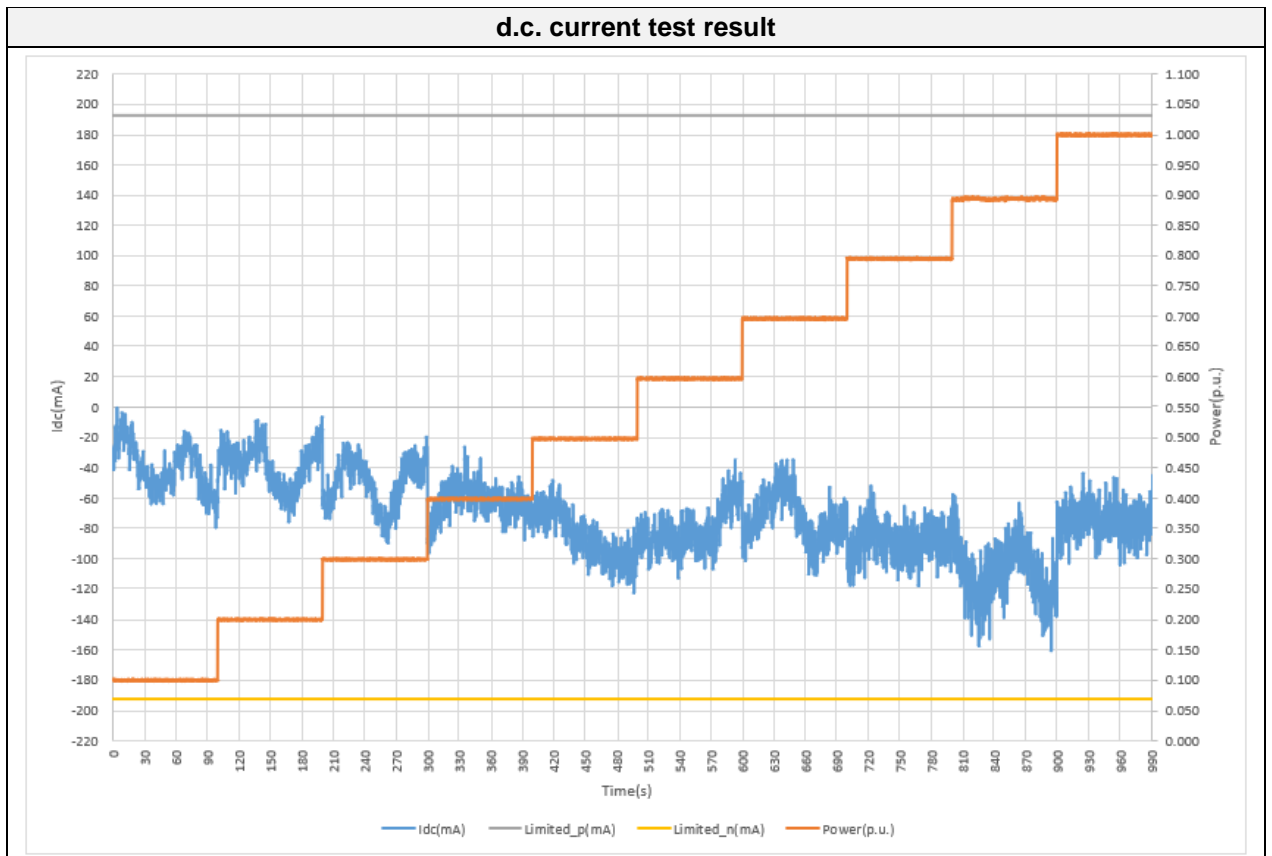

Measured protection time when d.c. current over 0.5%In						
Power Bin	10%Pn	20%Pn	30%Pn	40%Pn	50%Pn	Limited
Disconnection time(ms)	46	170	47	45	45	500
Power Bin	60%Pn	70%Pn	80%Pn	90%Pn	100%Pn	Limited
Disconnection time(ms)	45	46	45	45		500

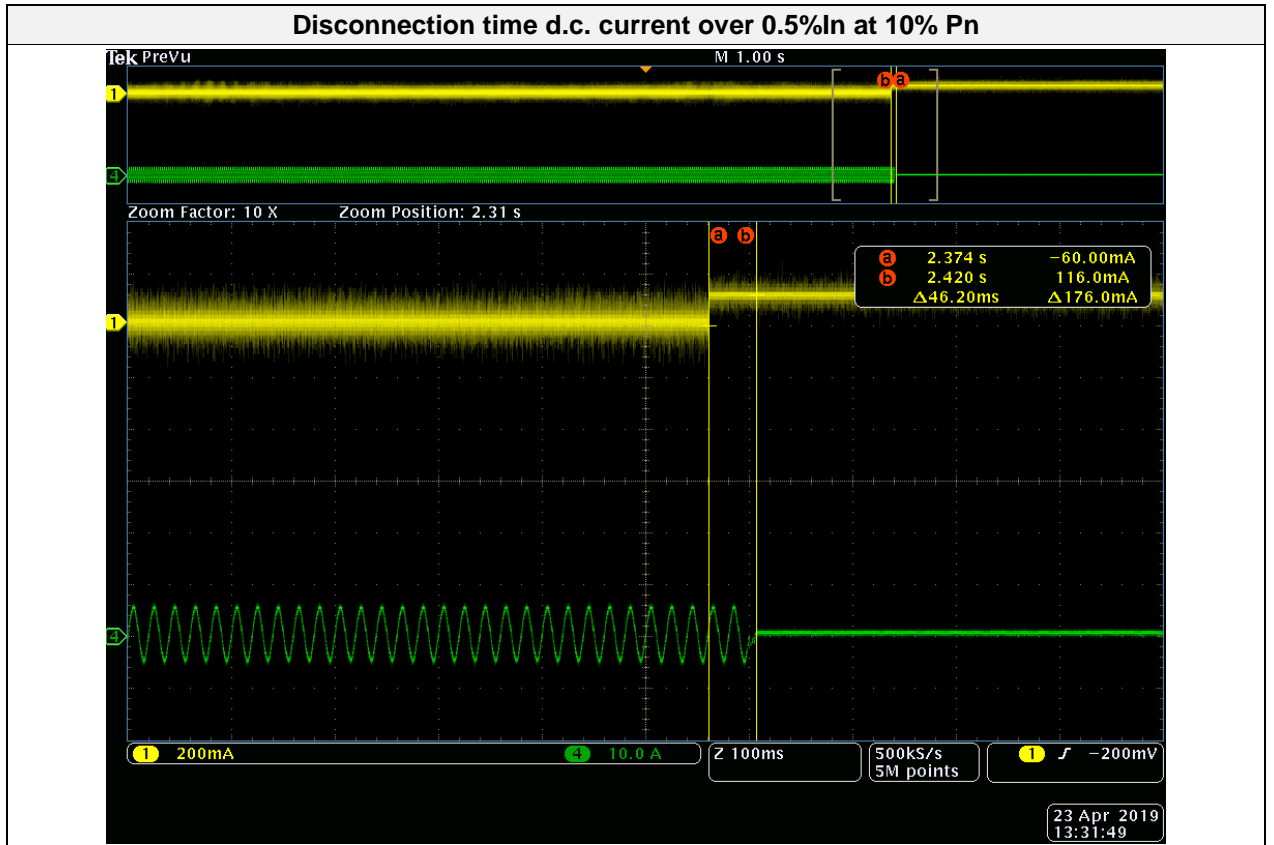

Disconnection time d.c. current over 0.5%In at 20% Pn

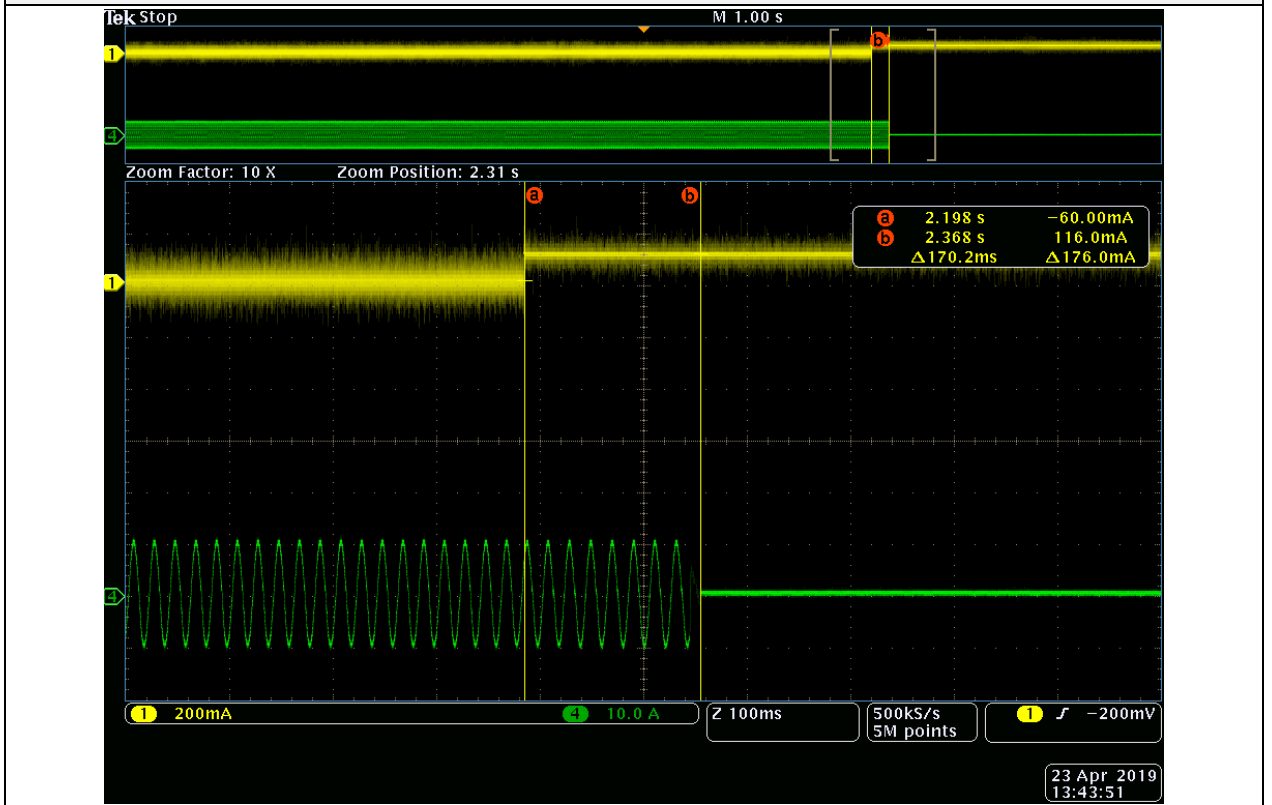

Disconnection time d.c. current over 0.5%In at 30% Pn

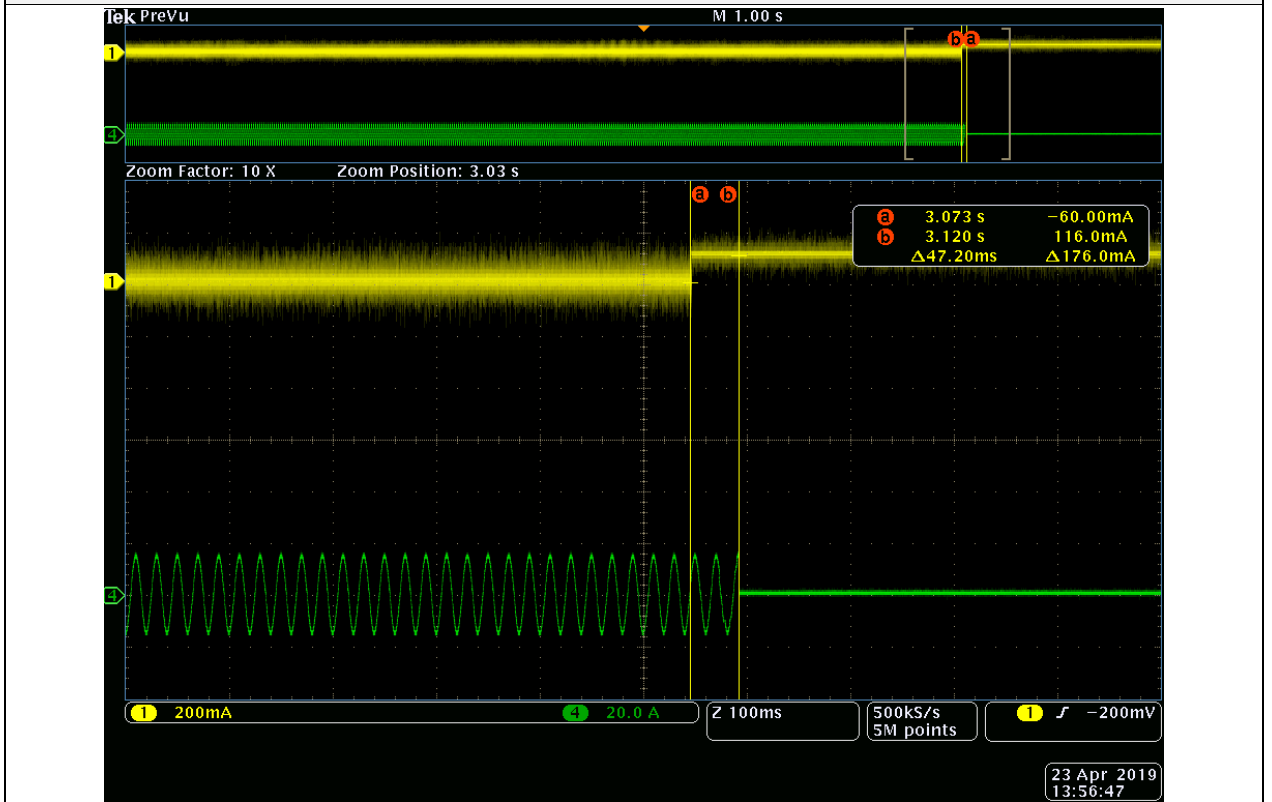

Disconnection time d.c. current over 0.5%In at 40% Pn

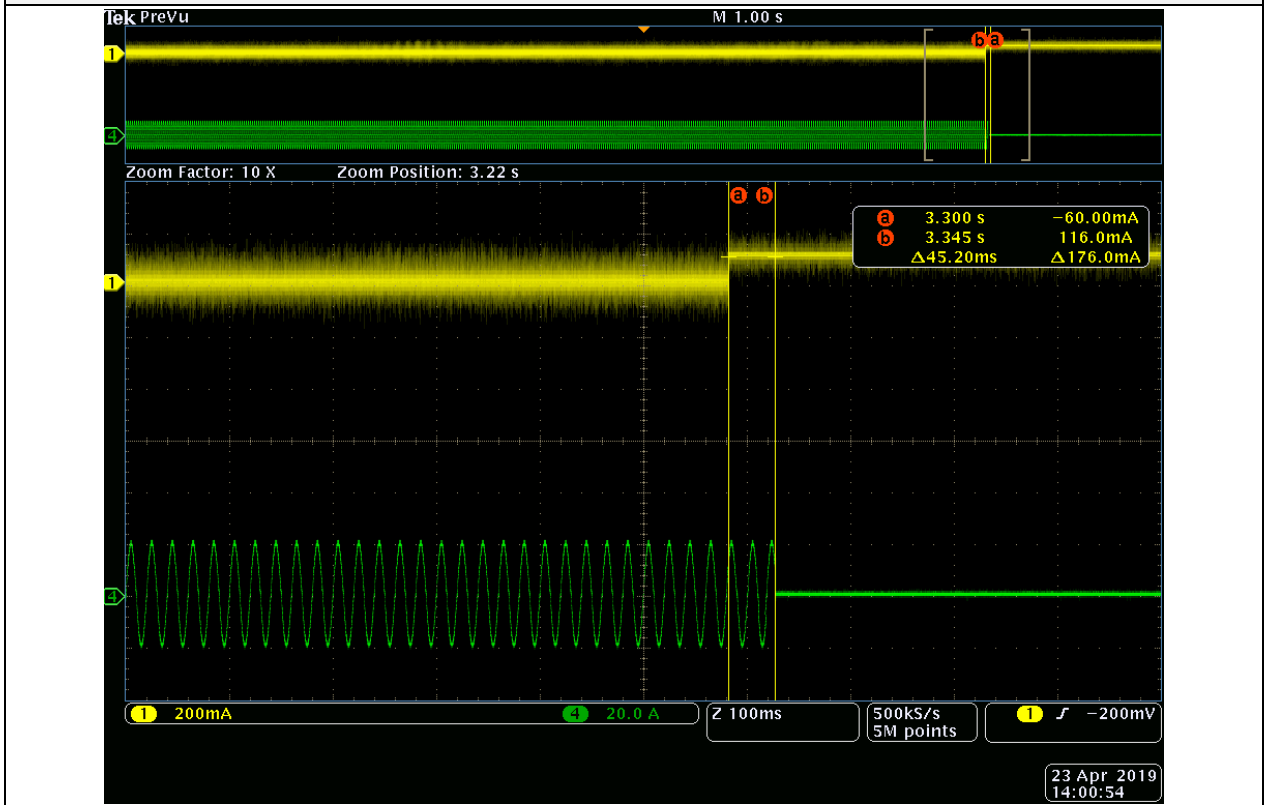

Disconnection time d.c. current over 0.5%In at 50% Pn

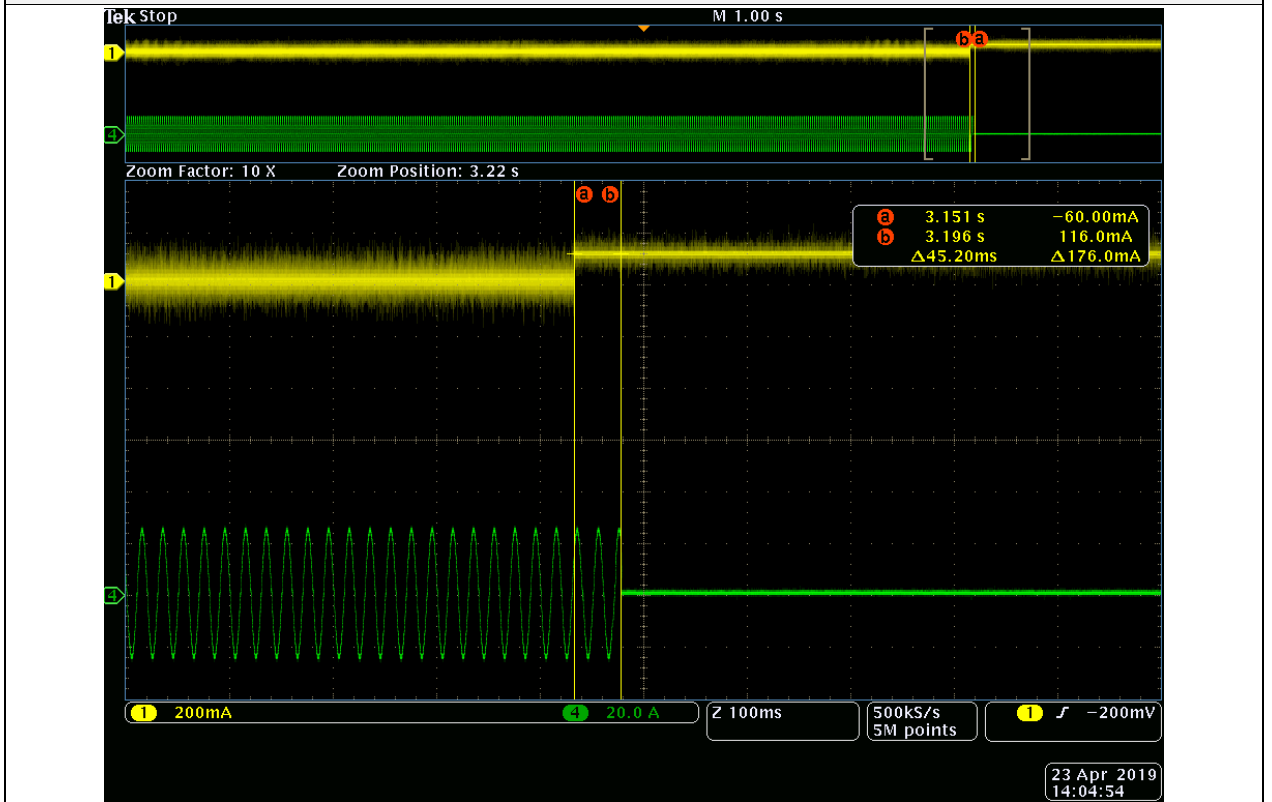

Disconnection time d.c. current over 0.5%In at 60% Pn

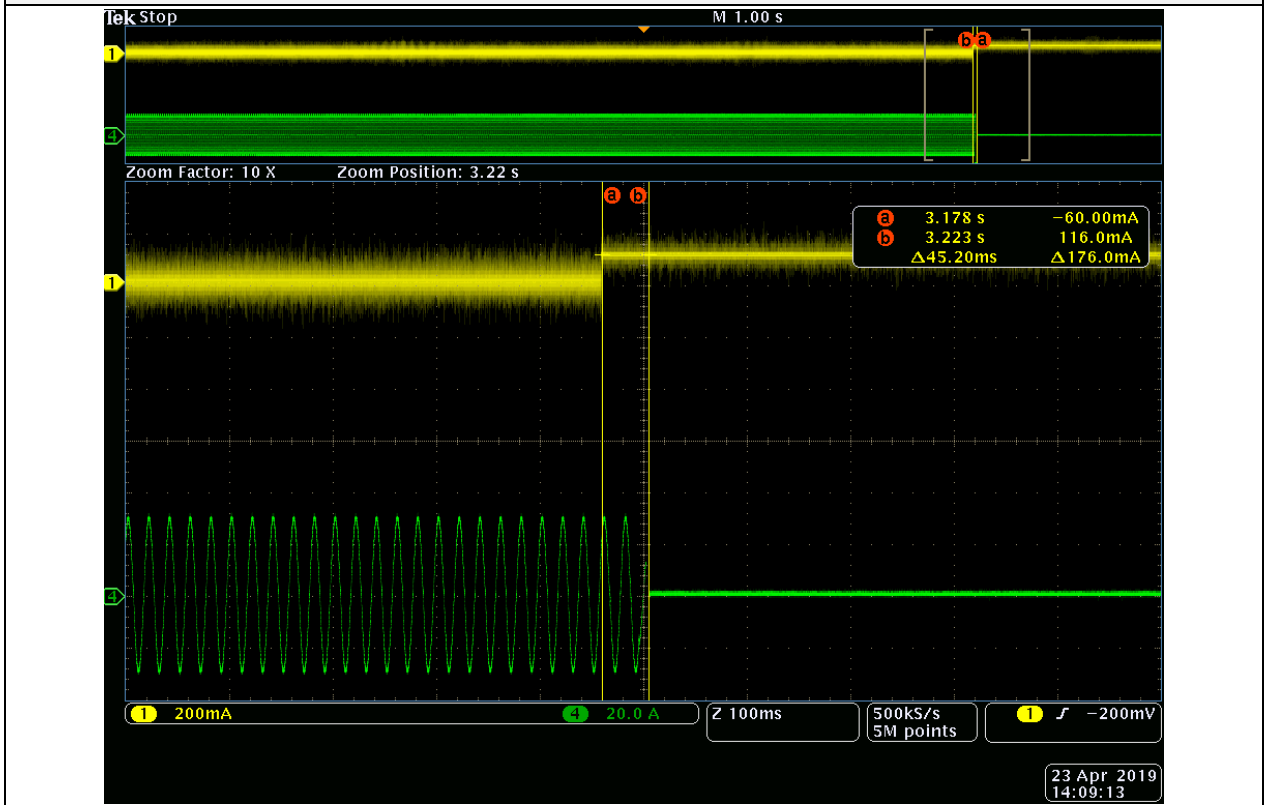

Disconnection time d.c. current over 0.5%In at 70% Pn

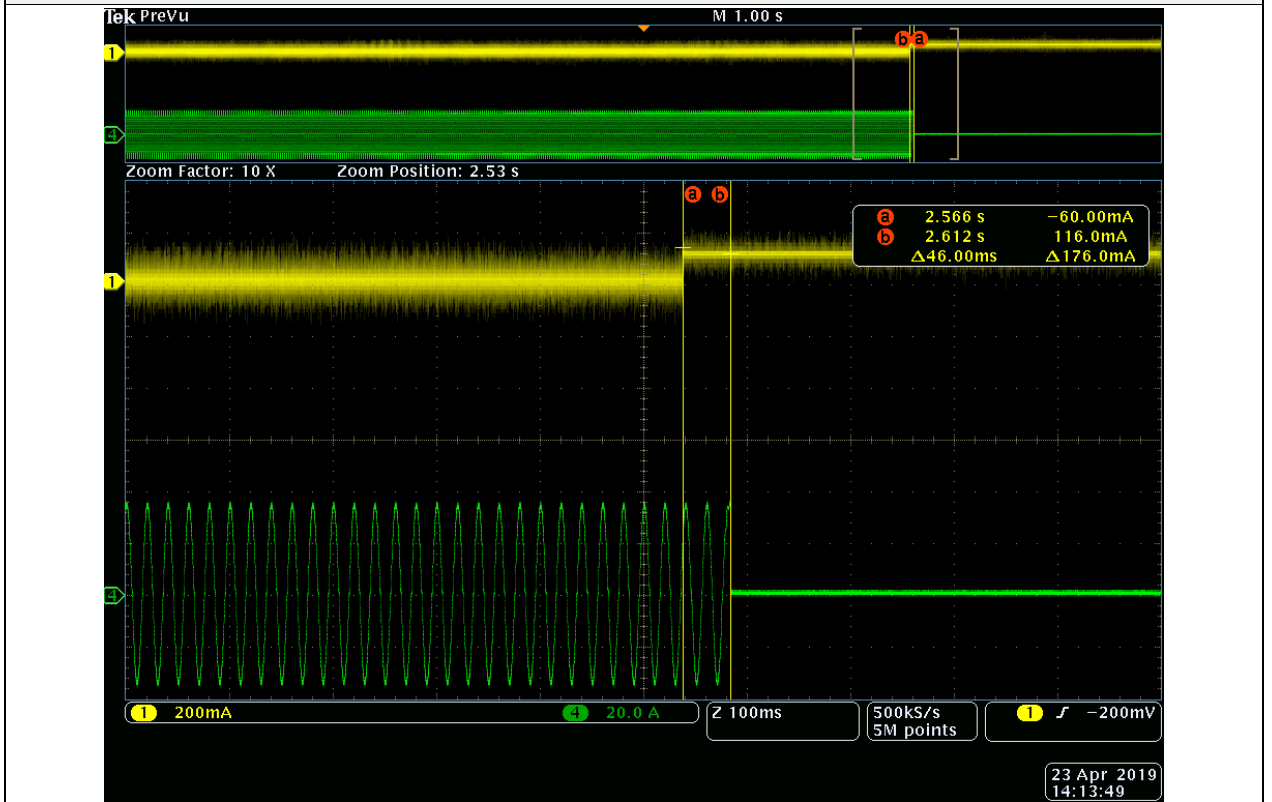

Disconnection time d.c. current over 0.5%In at 80% Pn

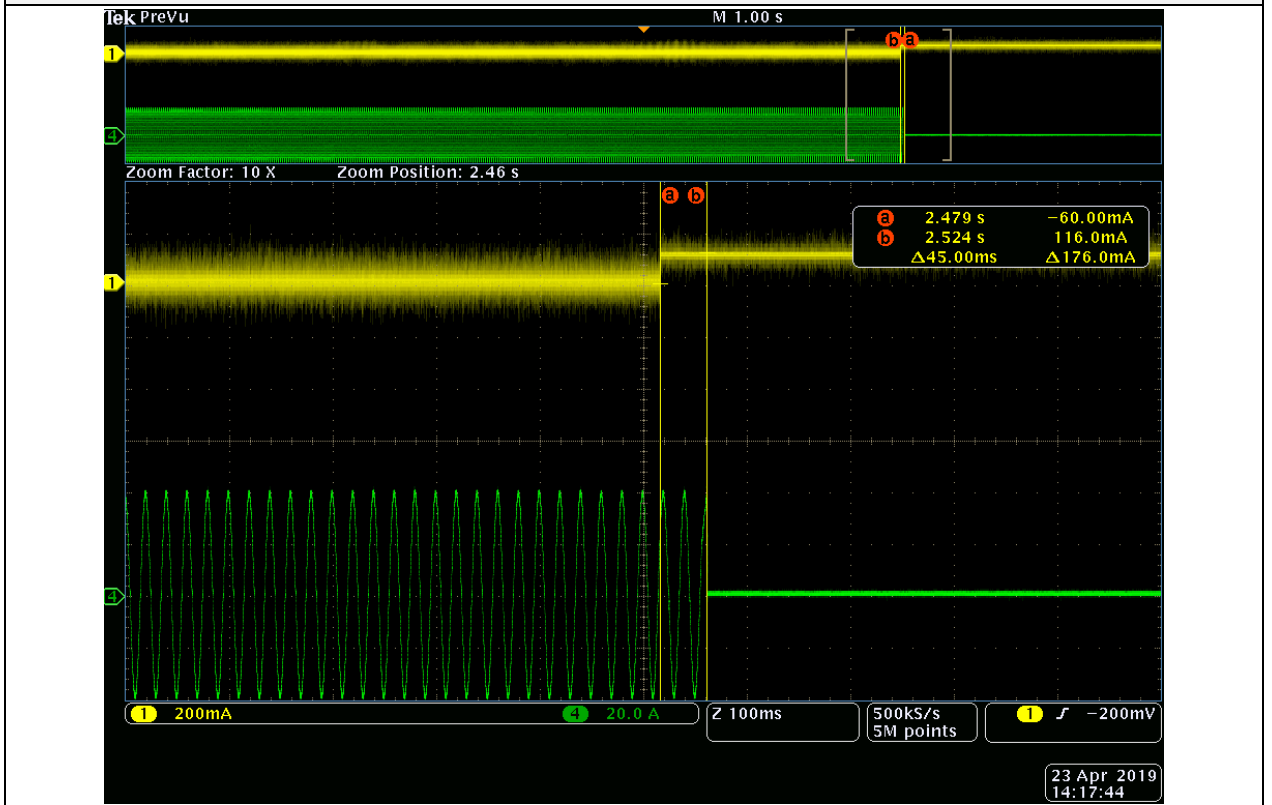

Disconnection time d.c. current over 0.5%In at 90% Pn

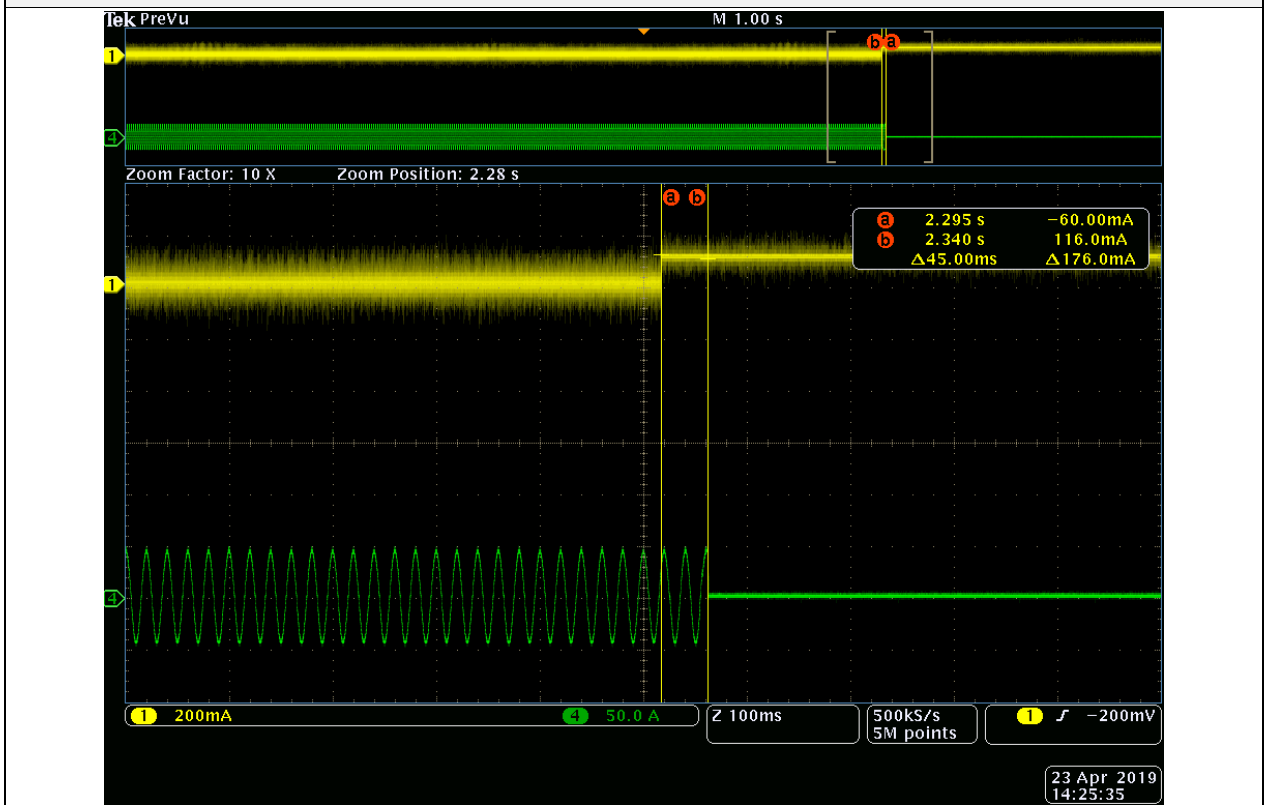

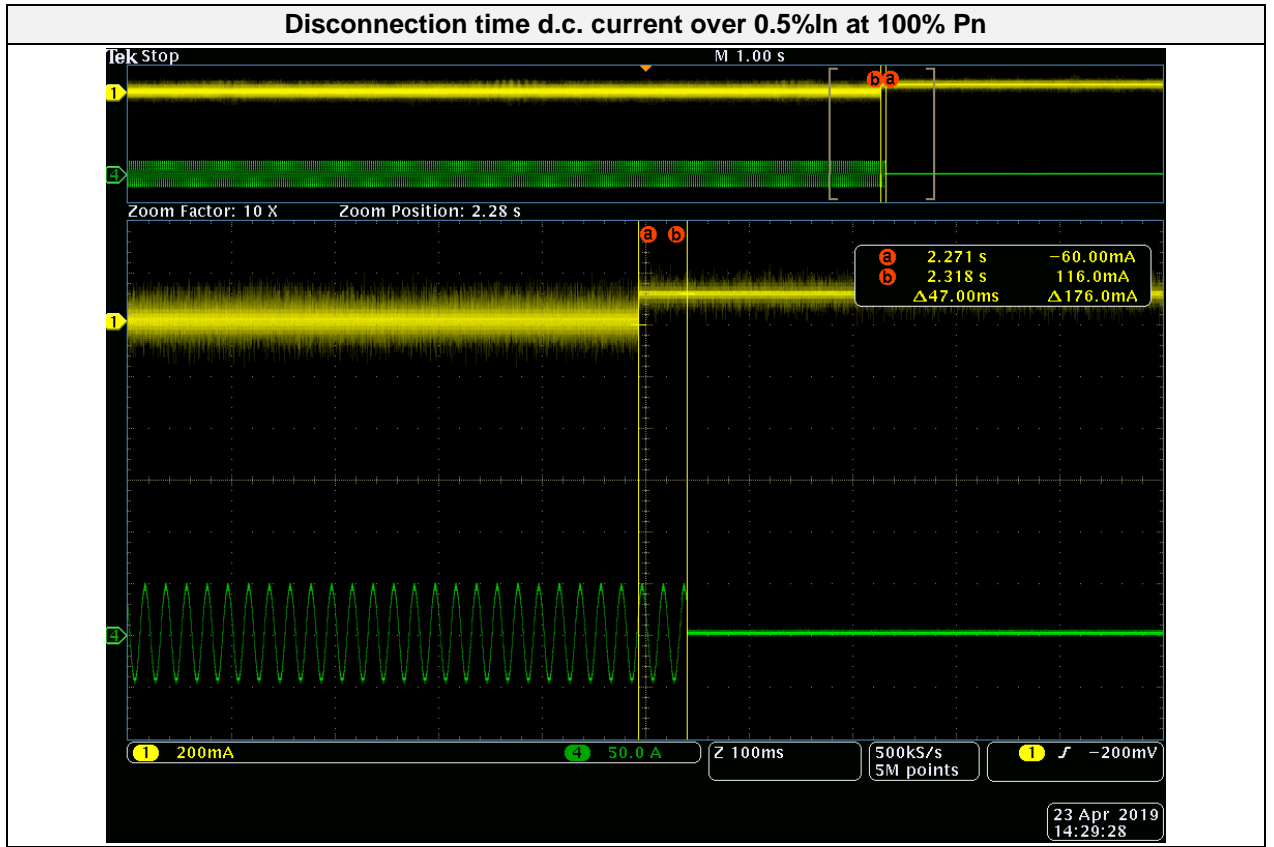

4.7 NORMAL FREQUENCY OPERATING RANGE

Normal frequency operating range tests have been measured according to Clause 4.1.9 of the standard. While the utility frequency is in the range of 47 Hz and 50.5 Hz, the system shall operate normally.

The results are offered in the table below:

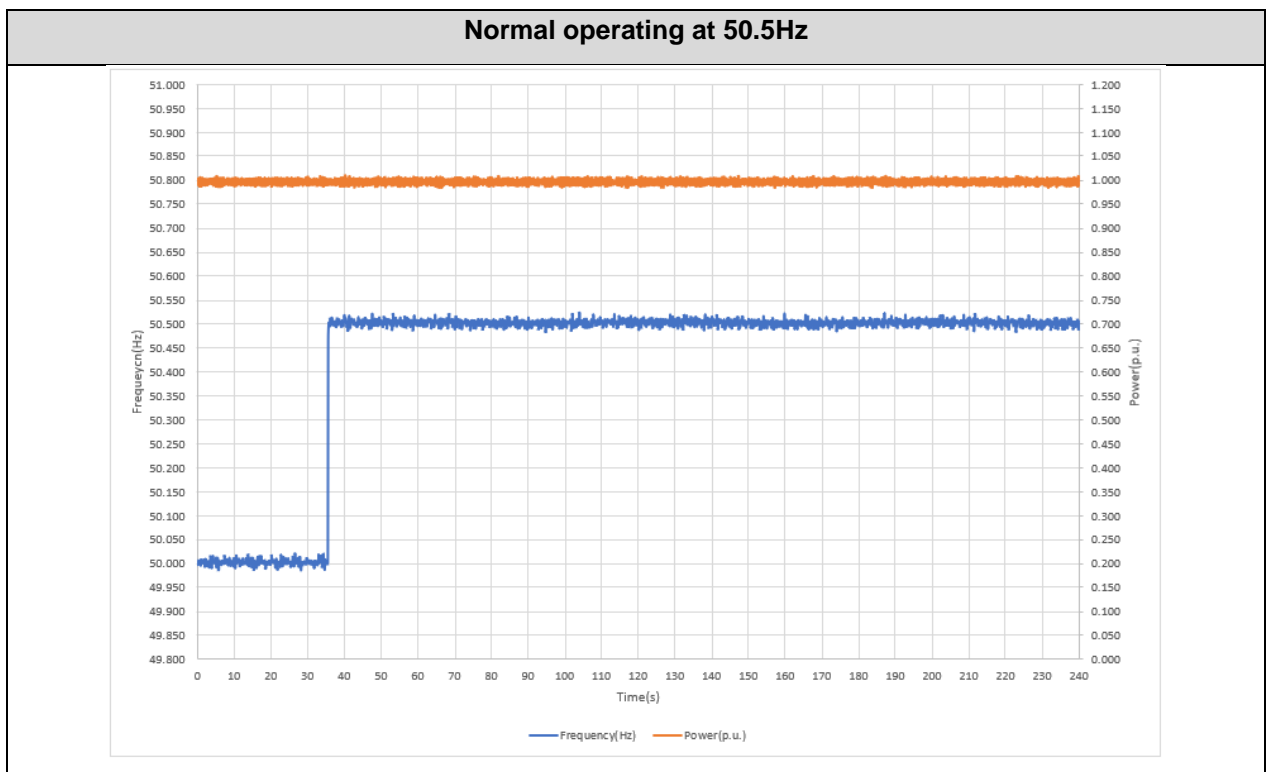
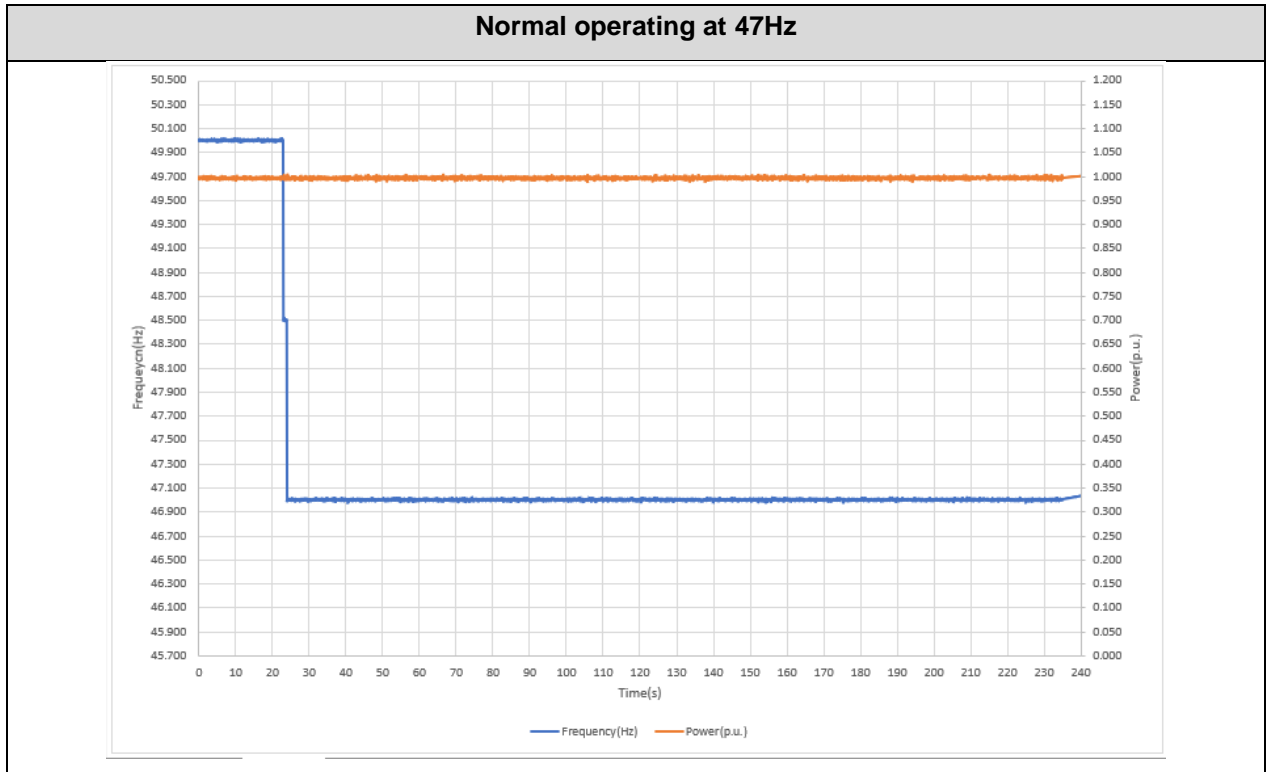

NRS 097-2-1: 2017 Edition 2

4.8 HARMONIC AND WAVEFORM DISTORTION

Harmonic and waveform distortion tests have been measured according to Clause 4.1.10 of the standard.

The values measured for current harmonics is respectively offered in the following points.

Pn(%)	0	10	20	30	40	50	60	70	80	90	100	LIMIT (%)
Nr. /Order	I_n(%)	I_n(%)	I_n(%)	I_n(%)	I_n(%)	I_n(%)	I_n(%)	I_n(%)	I_n(%)	I_n(%)	I_n(%)	
2	0.110	0.109	0.110	0.116	0.122	0.125	0.134	0.137	0.224	0.137	0.013	1
3	0.444	0.469	0.284	0.192	0.115	0.121	0.102	0.104	0.194	0.104	0.053	4
4	0.012	0.016	0.011	0.012	0.015	0.019	0.023	0.028	0.037	0.028	0.070	1
5	0.023	0.129	0.100	0.023	0.024	0.062	0.090	0.108	0.199	0.108	0.078	4
6	0.017	0.015	0.017	0.017	0.017	0.023	0.028	0.029	0.059	0.029	0.005	1
7	0.090	0.047	0.105	0.090	0.071	0.032	0.015	0.021	0.045	0.021	0.017	4
8	0.013	0.013	0.013	0.013	0.013	0.020	0.024	0.028	0.028	0.028	0.007	1
9	0.071	0.052	0.037	0.071	0.066	0.046	0.032	0.029	0.029	0.029	0.016	4
10	0.023	0.008	0.013	0.023	0.023	0.024	0.021	0.020	0.020	0.020	0.005	1
11	0.031	0.033	0.032	0.031	0.054	0.066	0.064	0.066	0.066	0.066	0.053	2
12	0.020	0.009	0.009	0.020	0.022	0.026	0.026	0.024	0.024	0.024	0.009	0.5
13	0.027	0.014	0.034	0.027	0.035	0.044	0.041	0.040	0.040	0.040	0.059	2
14	0.033	0.009	0.019	0.018	0.017	0.025	0.031	0.037	0.037	0.037	0.007	0.5
15	0.017	0.013	0.020	0.023	0.013	0.033	0.047	0.049	0.049	0.049	0.017	2
16	0.016	0.011	0.010	0.016	0.019	0.017	0.014	0.017	0.017	0.017	0.003	0.5
17	0.016	0.016	0.015	0.023	0.020	0.016	0.023	0.032	0.032	0.032	0.019	1.5
18	0.012	0.007	0.013	0.015	0.013	0.016	0.020	0.020	0.020	0.020	0.004	0.38
19	0.014	0.010	0.015	0.016	0.028	0.017	0.026	0.028	0.028	0.028	0.008	1.5
20	0.014	0.008	0.012	0.010	0.015	0.013	0.012	0.015	0.015	0.015	0.003	0.38
21	0.018	0.008	0.015	0.016	0.023	0.021	0.012	0.012	0.012	0.012	0.008	1.5
22	0.031	0.009	0.010	0.010	0.017	0.016	0.014	0.014	0.014	0.014	0.007	0.38
23	0.031	0.010	0.014	0.012	0.016	0.031	0.018	0.014	0.014	0.014	0.018	0.6
24	0.041	0.006	0.012	0.015	0.014	0.024	0.023	0.018	0.018	0.018	0.004	0.15
25	0.023	0.014	0.013	0.023	0.023	0.027	0.035	0.031	0.031	0.031	0.030	0.6
26	0.034	0.018	0.018	0.024	0.020	0.025	0.031	0.031	0.031	0.031	0.013	0.15
27	0.021	0.008	0.014	0.021	0.032	0.023	0.031	0.034	0.034	0.034	0.038	0.6
28	0.017	0.026	0.035	0.038	0.057	0.048	0.055	0.063	0.063	0.063	0.011	0.15
29	0.018	0.053	0.073	0.079	0.110	0.089	0.095	0.098	0.098	0.098	0.020	0.6
30	0.035	0.040	0.053	0.053	0.062	0.061	0.063	0.066	0.066	0.066	0.013	0.15
31	0.023	0.012	0.025	0.028	0.042	0.034	0.041	0.040	0.040	0.040	0.026	0.6
32	0.028	0.008	0.013	0.015	0.023	0.020	0.023	0.032	0.032	0.032	0.004	0.15
33	0.018	0.011	0.014	0.021	0.028	0.032	0.034	0.043	0.043	0.043	0.016	0.6
34	0.016	0.011	0.011	0.015	0.018	0.021	0.021	0.024	0.024	0.024	0.008	0.15
35	0.018	0.011	0.013	0.012	0.016	0.022	0.017	0.024	0.024	0.024	0.006	0.3
36	0.011	0.009	0.010	0.012	0.018	0.018	0.018	0.018	0.018	0.018	0.005	0.08
37	0.020	0.012	0.014	0.015	0.026	0.017	0.035	0.032	0.032	0.032	0.012	0.3
38	0.026	0.009	0.016	0.017	0.019	0.024	0.020	0.023	0.023	0.023	0.011	0.08
39	0.011	0.008	0.014	0.025	0.018	0.028	0.026	0.028	0.028	0.028	0.011	0.3
40	0.011	0.007	0.013	0.020	0.023	0.025	0.023	0.021	0.021	0.021	0.013	0.08
41	0.003	0.008	0.005	0.008	0.022	0.014	0.021	0.020	0.020	0.020	0.006	0.3
42	0.008	0.012	0.007	0.005	0.003	0.000	0.003	0.012	0.012	0.012	0.016	0.08
43	0.002	0.009	0.006	0.001	0.008	0.012	0.014	0.023	0.023	0.023	0.004	0.3
44	0.004	0.009	0.009	0.005	0.002	0.001	0.001	0.004	0.004	0.004	0.012	0.08
45	0.002	0.009	0.007	0.008	0.004	0.002	0.003	0.004	0.004	0.004	0.014	0.3
46	0.009	0.011	0.010	0.008	0.002	0.002	0.002	0.002	0.002	0.002	0.015	0.08
47	0.000	0.008	0.006	0.005	0.006	0.003	0.015	0.012	0.012	0.012	0.008	0.3
48	0.006	0.011	0.004	0.003	0.001	0.004	0.000	0.003	0.003	0.003	0.009	0.08
49	0.009	0.012	0.006	0.005	0.002	0.008	0.006	0.008	0.008	0.008	0.009	0.3

NRS 097-2-1: 2017 Edition 2

Pn(%)	0	10	20	30	40	50	60	70	80	90	100	LIMIT (%)	
Nr. /Order	I _h (%)	I _h (%)	I _h (%)	I _h (%)	I _h (%)	I _h (%)	I _h (%)	I _h (%)	I _h (%)	I _h (%)	I _h (%)	I _h (%)	(%)
50	0.009	0.013	0.007	0.000	0.003	0.005	0.003	0.001	0.001	0.001	0.001	0.007	0.08
THD(%)	1.205	1.129	1.127	1.107	1.142	1.162	1.186	1.222	1.351	1.222	0.849	5	

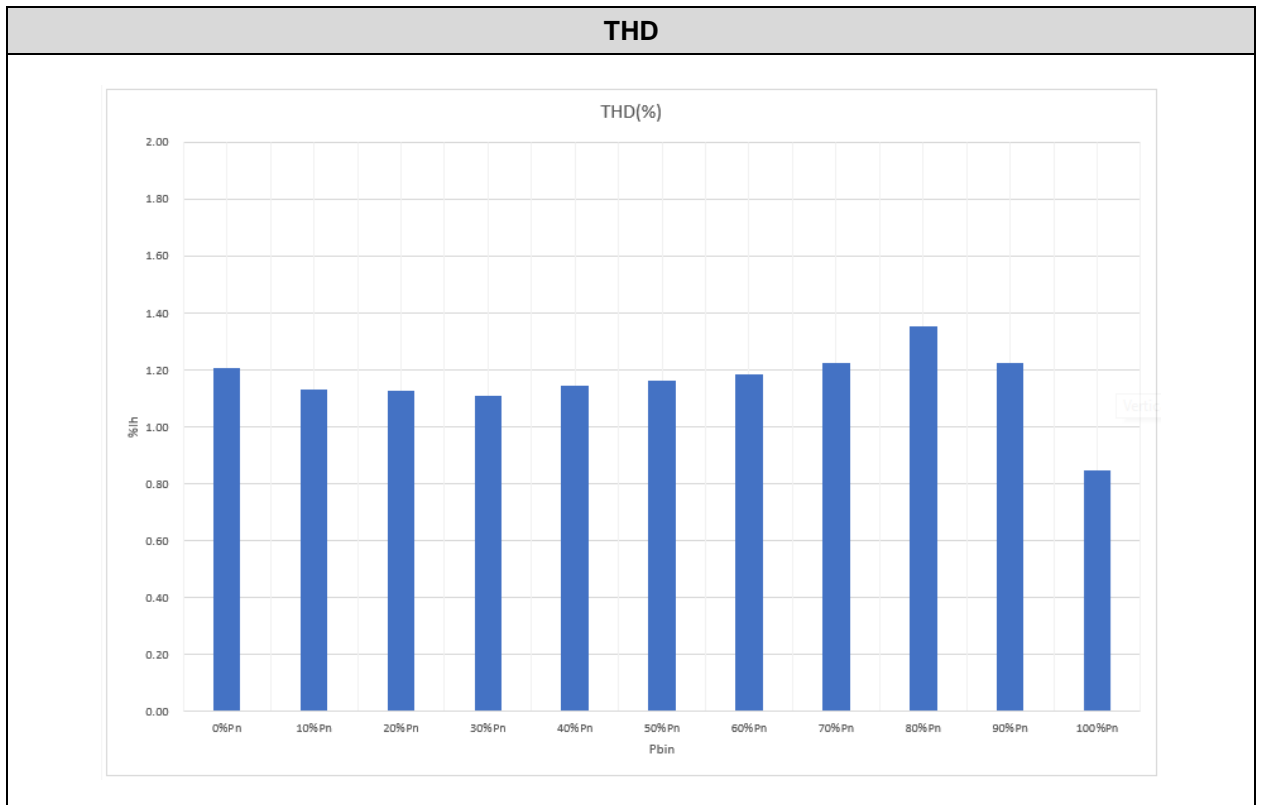
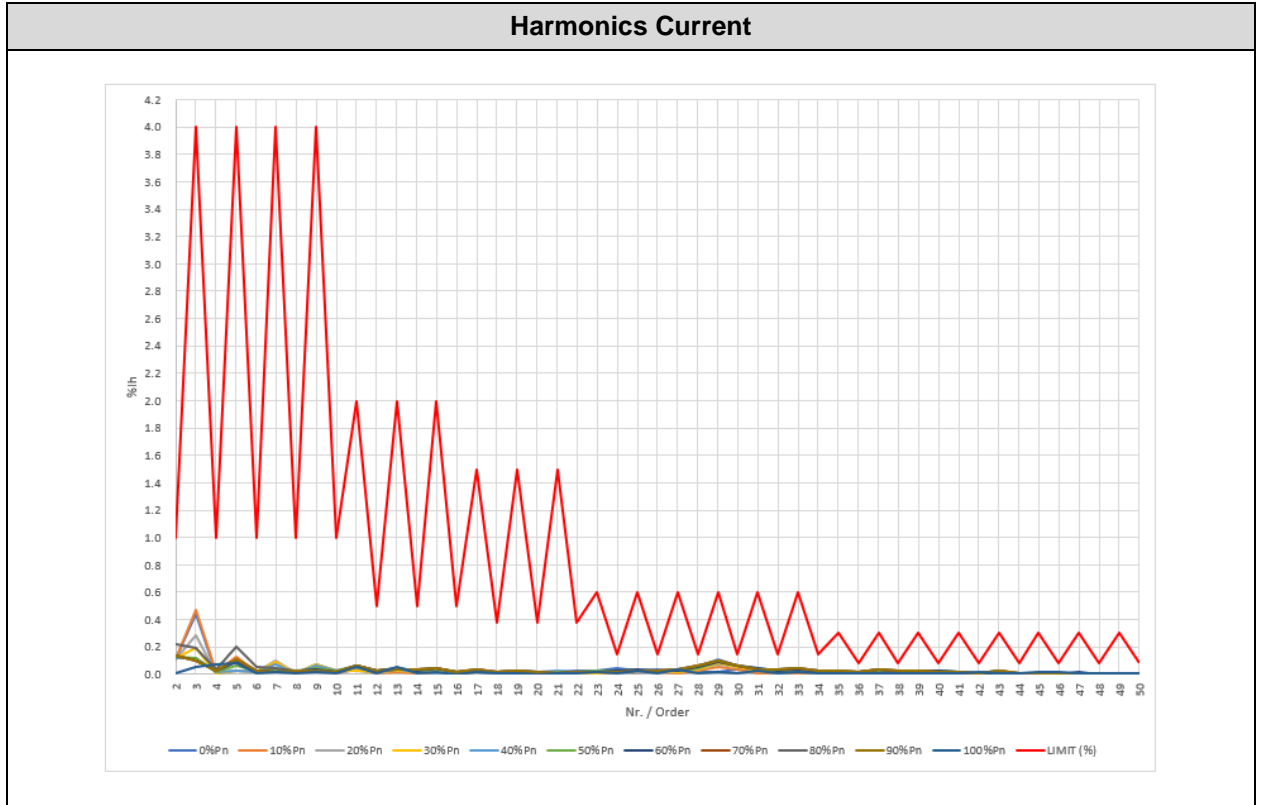

NRS 097-2-1: 2017 Edition 2

Power P/Pn[%]	0	10	20	30	40	50	60	70	80	90	100	LIMIT (%)
Frequency [Hz]	I _h (%)	I _h (%)	I _h (%)	I _h (%)	I _h (%)	I _h (%)	I _h (%)	I _h (%)	I _h (%)	I _h (%)	I _h (%)	
75	0.000	0.014	0.020	0.034	0.036	0.037	0.048	0.051	0.064	0.064	0.087	0.1
125	0.000	0.004	0.008	0.009	0.014	0.016	0.017	0.019	0.024	0.025	0.035	0.1
175	0.000	0.007	0.008	0.009	0.016	0.014	0.013	0.013	0.015	0.019	0.020	0.1
225	0.000	0.006	0.008	0.010	0.006	0.010	0.017	0.013	0.017	0.019	0.016	0.1
275	0.000	0.004	0.006	0.006	0.008	0.009	0.008	0.008	0.010	0.012	0.009	0.1
325	0.000	0.004	0.006	0.006	0.011	0.015	0.010	0.012	0.007	0.016	0.012	0.1
375	0.000	0.005	0.006	0.008	0.010	0.010	0.011	0.010	0.013	0.015	0.019	0.1
425	0.000	0.005	0.008	0.008	0.011	0.009	0.009	0.009	0.009	0.011	0.016	0.1
475	0.000	0.005	0.006	0.005	0.012	0.012	0.014	0.012	0.015	0.010	0.017	0.1
525	0.000	0.005	0.014	0.006	0.015	0.014	0.012	0.009	0.019	0.016	0.019	0.1
575	0.000	0.005	0.008	0.008	0.010	0.014	0.011	0.014	0.015	0.014	0.020	0.25
625	0.000	0.005	0.006	0.006	0.010	0.011	0.012	0.016	0.020	0.015	0.015	0.25
675	0.000	0.007	0.006	0.011	0.011	0.010	0.014	0.013	0.011	0.021	0.017	0.25
725	0.000	0.004	0.007	0.006	0.009	0.014	0.012	0.012	0.011	0.022	0.020	0.25
775	0.000	0.005	0.007	0.007	0.010	0.012	0.009	0.010	0.013	0.012	0.014	0.25
825	0.000	0.004	0.009	0.005	0.011	0.014	0.012	0.009	0.011	0.015	0.013	0.25
875	0.000	0.005	0.008	0.010	0.016	0.018	0.012	0.010	0.013	0.017	0.014	0.19
925	0.000	0.006	0.010	0.008	0.013	0.012	0.013	0.010	0.009	0.020	0.019	0.19
975	0.000	0.007	0.007	0.011	0.009	0.012	0.009	0.009	0.014	0.016	0.018	0.19
1025	0.000	0.007	0.008	0.006	0.011	0.017	0.013	0.013	0.014	0.017	0.020	0.19
1075	0.000	0.007	0.011	0.011	0.010	0.007	0.013	0.015	0.012	0.015	0.016	0.19
1125	0.000	0.006	0.008	0.010	0.008	0.009	0.015	0.012	0.016	0.015	0.027	0.19
1175	0.000	0.007	0.011	0.004	0.017	0.014	0.012	0.015	0.010	0.020	0.019	0.08
1225	0.000	0.007	0.014	0.012	0.011	0.014	0.021	0.022	0.019	0.016	0.016	0.08
1275	0.000	0.010	0.012	0.012	0.018	0.017	0.021	0.022	0.021	0.017	0.019	0.08
1325	0.000	0.008	0.013	0.009	0.013	0.013	0.020	0.025	0.024	0.012	0.024	0.08
1375	0.000	0.010	0.012	0.009	0.021	0.020	0.015	0.017	0.022	0.023	0.026	0.08
1425	0.000	0.023	0.023	0.032	0.026	0.033	0.042	0.039	0.039	0.054	0.054	0.08
1475	0.000	0.045	0.051	0.067	0.060	0.069	0.072	0.076	0.065	0.040	0.063	0.08
1525	0.000	0.027	0.035	0.039	0.038	0.039	0.040	0.045	0.049	0.047	0.057	0.08
1575	0.000	0.010	0.016	0.015	0.020	0.023	0.020	0.027	0.027	0.032	0.031	0.08
1625	0.000	0.008	0.012	0.014	0.015	0.014	0.022	0.021	0.021	0.033	0.034	0.08
1675	0.000	0.012	0.013	0.017	0.016	0.019	0.025	0.026	0.029	0.042	0.036	0.08
1725	0.000	0.006	0.012	0.016	0.020	0.015	0.026	0.018	0.031	0.031	0.048	0.08
1775	0.000	0.010	0.013	0.014	0.013	0.016	0.016	0.017	0.021	0.024	0.023	0.03
1825	0.000	0.009	0.001	0.016	0.014	0.010	0.023	0.019	0.018	0.011	0.013	0.03
1875	0.000	0.006	0.002	0.014	0.015	0.018	0.016	0.020	0.014	0.013	0.028	0.03
1925	0.000	0.010	0.002	0.015	0.018	0.016	0.017	0.027	0.012	0.017	0.010	0.03
1975	0.000	0.014	0.002	0.018	0.014	0.023	0.021	0.021	0.022	0.028	0.015	0.03
2025	0.000	0.007	0.008	0.006	0.011	0.017	0.013	0.013	0.014	0.017	0.020	0.03
2075	0.000	0.007	0.011	0.011	0.010	0.007	0.013	0.015	0.012	0.015	0.016	0.03
2125	0.000	0.006	0.008	0.010	0.008	0.009	0.015	0.012	0.016	0.015	0.027	0.03
2175	0.000	0.007	0.011	0.004	0.017	0.014	0.012	0.015	0.010	0.020	0.019	0.03
2225	0.000	0.007	0.014	0.012	0.011	0.014	0.021	0.022	0.019	0.016	0.016	0.03
2275	0.000	0.010	0.012	0.012	0.018	0.017	0.021	0.022	0.021	0.017	0.019	0.03
2325	0.000	0.008	0.013	0.009	0.013	0.013	0.020	0.025	0.024	0.012	0.024	0.03
2375	0.000	0.010	0.012	0.009	0.021	0.020	0.015	0.017	0.022	0.023	0.026	0.03
2425	0.000	0.023	0.023	0.012	0.026	0.013	0.022	0.019	0.019	0.024	0.024	0.03
2475	0.000	0.025	0.021	0.027	0.020	0.028	0.022	0.026	0.025	0.020	0.023	0.03
2525	0.000	0.027	0.015	0.019	0.018	0.019	0.020	0.025	0.028	0.027	0.027	0.03
2575	0.000	0.010	0.016	0.015	0.020	0.023	0.020	0.027	0.027	0.012	0.011	0.03
2625	0.000	0.008	0.012	0.014	0.015	0.014	0.022	0.021	0.021	0.013	0.014	0.03
2675	0.000	0.012	0.013	0.017	0.016	0.019	0.025	0.026	0.028	0.022	0.016	0.03

NRS 097-2-1: 2017 Edition 2

Power P/Pn[%]	0	10	20	30	40	50	60	70	80	90	100	LIMIT (%)
Frequency [Hz]	I _h (%)	I _h (%)	I _h (%)	I _h (%)	I _h (%)	I _h (%)	I _h (%)	I _h (%)	I _h (%)	I _h (%)	I _h (%)	
2725	0.000	0.006	0.012	0.016	0.020	0.015	0.026	0.018	0.011	0.011	0.028	0.03
2775	0.000	0.010	0.013	0.014	0.013	0.016	0.016	0.017	0.021	0.024	0.023	0.03
2825	0.000	0.009	0.001	0.016	0.014	0.010	0.023	0.019	0.028	0.021	0.013	0.03
2875	0.000	0.006	0.002	0.014	0.015	0.018	0.016	0.020	0.024	0.023	0.028	0.03
2925	0.000	0.010	0.002	0.015	0.018	0.016	0.017	0.027	0.012	0.017	0.020	0.03
2975	0.000	0.014	0.002	0.018	0.014	0.023	0.021	0.021	0.022	0.028	0.015	0.03
3025	0.000	0.006	0.012	0.016	0.020	0.015	0.026	0.018	0.011	0.011	0.028	0.03

Inter - harmonics Current

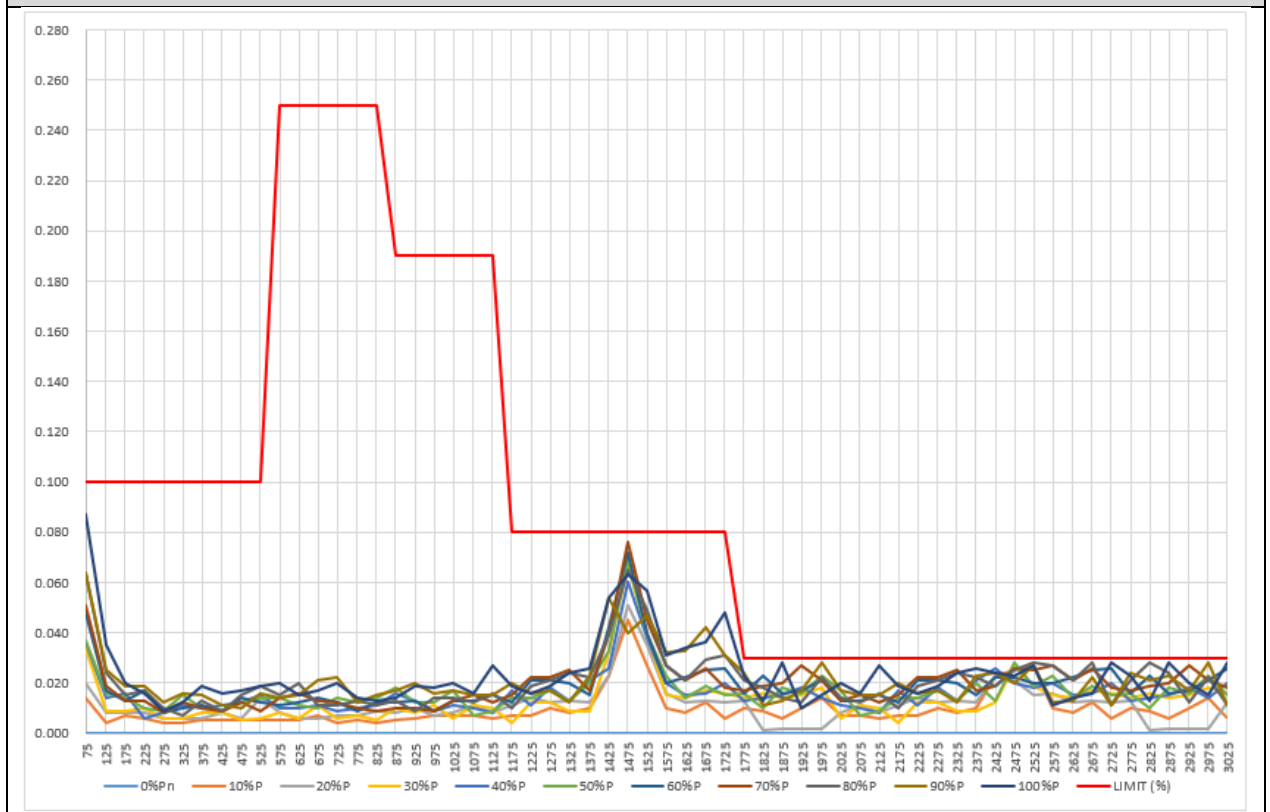

4.9 POWER FACTOR

Power factor tests have been measured according to Clause 4.1.11 of the standard.

Three different tests have been done:

- Test 1: PF=1
- Test 2: Rectangular Curve Q fixed ($Q=\pm 30\% S_n$)
- Test 3: Triangular Curve PF fixed ($PF=\pm 0.8$)
- Test 4: Semicircular Curve S fixed ($S=100\% S_n$)
- Test 5: Settable to operate according to a characteristic curve

As the inverter is capable of different power factor settings, the test has been repeated varying the power factor within the range 0.8 leading to 0.8(*) lagging.

(*)0.8 leading to 0.8 lagging is more restrictive than 0.95 as the standard required.

The maximum tolerance allowed for the measured Power Factor is ± 0.01 , for measurements from 25% S_n .

4.9.1 Test 1: PF=1

The following table and graphs show test results for measurements of power factor set to unity (PF=1):

Unity Power Factor (PF=1.0)					
P Desired (%Sn)	P measured (%Sn)	Q measured (%Sn)	Power Factor desired (cos φ)	Power Factor measured (cos φ)	Power Factor Deviation (cos φ)
3%	3.5	3.9	1.000	0.671	-0.329
8%	8.5	3.3	1.000	0.930	-0.070
10%	10.5	3.2	1.000	0.957	-0.043
15%	15.5	2.8	1.000	0.984	-0.016
18%	18.5	2.7	1.000	0.990	-0.010
20%	20.6	2.6	1.000	0.992	-0.008
25%	25.5	2.6	1.000	0.995	-0.005
28%	28.6	2.6	1.000	0.996	-0.004
30%	30.4	3.3	1.000	0.994	-0.006
33%	33.6	3.3	1.000	0.995	-0.005
37%	37.7	3.2	1.000	0.996	-0.004
40%	40.5	3.1	1.000	0.997	-0.003
43%	43.5	3.1	1.000	0.997	-0.003
47%	47.3	3.1	1.000	0.998	-0.002
50%	50.4	3.1	1.000	0.998	-0.002
53%	53.4	3.1	1.000	0.998	-0.002
57%	57.0	3.1	1.000	0.999	-0.001
60%	60.2	3.1	1.000	0.999	-0.001
63%	63.2	-3.2	1.000	0.999	-0.001
67%	67.0	-3.3	1.000	0.999	-0.001
70%	69.8	-3.4	1.000	0.999	-0.001
75%	74.5	-3.5	1.000	0.999	-0.001
78%	77.9	-3.6	1.000	0.999	-0.001
80%	80.0	-3.7	1.000	0.999	-0.001
84%	83.8	-3.8	1.000	0.999	-0.001
87%	86.8	-4.0	1.000	0.999	-0.001
90%	90.0	-4.1	1.000	0.999	-0.001
92%	92.0	-4.2	1.000	0.999	-0.001
94%	94.1	-4.3	1.000	0.999	-0.001
96%	96.0	-4.4	1.000	0.999	-0.001
98%	97.8	-4.5	1.000	0.999	-0.001
100%	100.2	-4.7	1.000	0.999	-0.001

Unity Power Factor (PF=1.0)

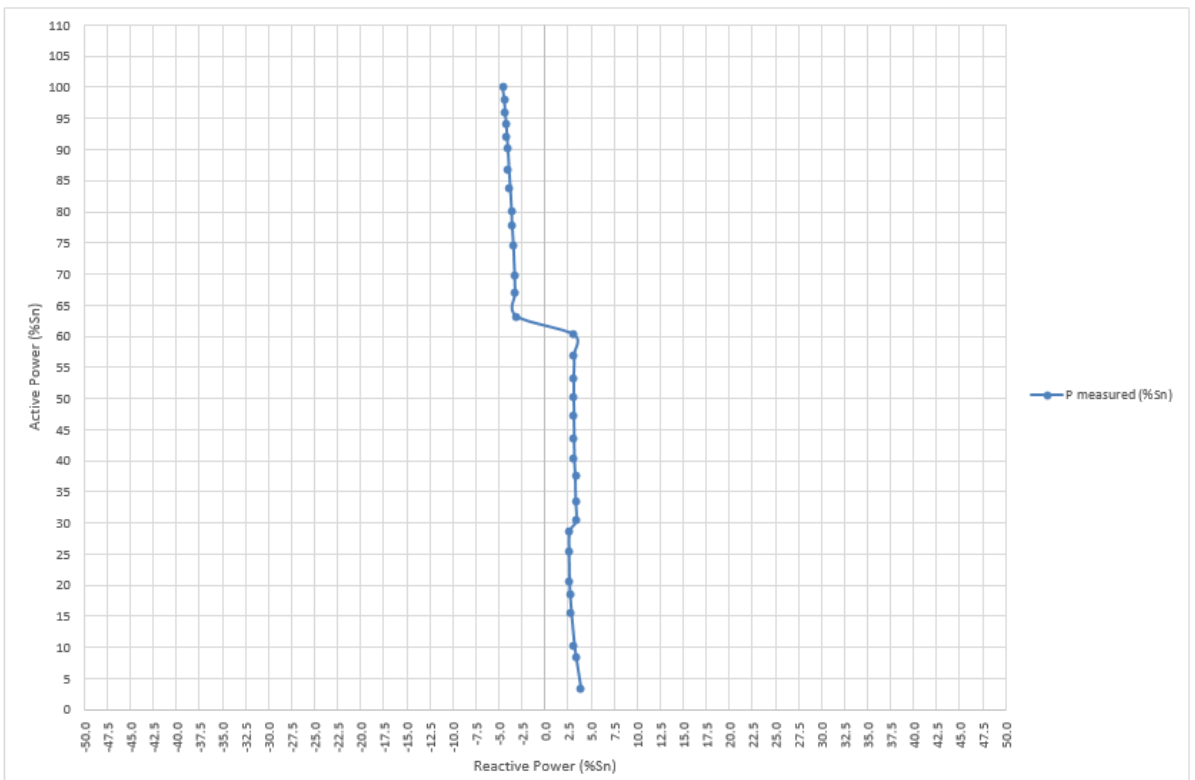
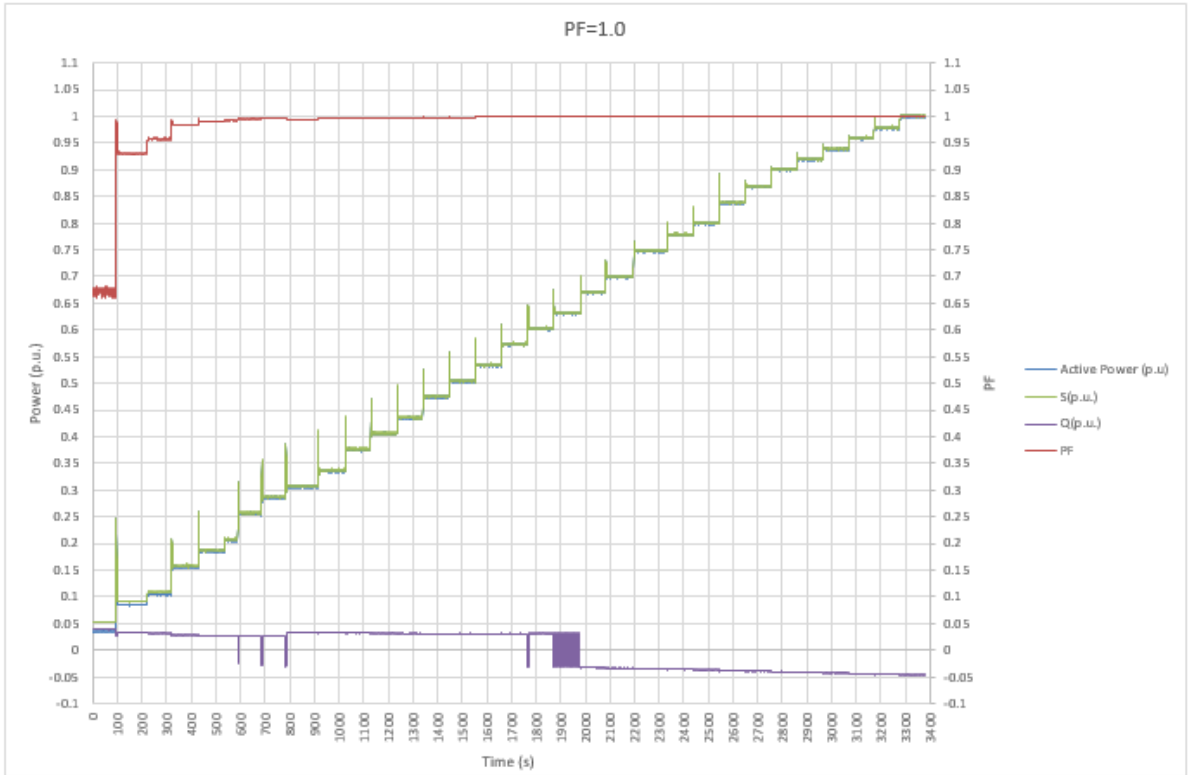

NRS 097-2-1: 2017 Edition 2
4.9.2 Test 2: Rectangular Curve ($Q = \pm 30\%S_n$)

This test verifies the capability of the inverter to provide a fixed value of reactive power. In addition, it is verified the Q control mode.

At high active power levels the reactive power provided by the inverter is automatically limited by the inverter in order to protect against over current.

Allowed tolerance to be considered is 5%Sn when possible.

The following table shows the test results:

Rectangular Curve ($Q=30.0\%S_n$ / Inductive)					
P Desired (%Sn)	P measured (%Sn)	Q desired (%Sn)	Q measured (%Sn)	Q Deviation (%Sn)	Power Factor (cos ϕ)
0%	0.1	<10(*)	4.3(*)	--	0.028
3%	3.5	<10(*)	4.9(*)	--	0.585
8%	8.5	<10(*)	5.8(*)	--	0.823
10%	10.4	<10(*)	7.6(*)	--	0.809
15%	15.5	<10(*)	10.4(*)	--	0.830
18%	18.5	<30(*)	13.0(*)	--	0.818
20%	20.5	<30(*)	15.6(*)	--	0.795
25%	25.3	30.0	30.0	0.0	0.644
28%	28.2	30.0	30.4	0.4	0.681
30%	30.3	30.0	30.5	0.5	0.705
33%	33.2	30.0	30.4	0.4	0.737
37%	37.2	30.0	30.5	0.5	0.773
40%	40.2	30.0	30.2	0.2	0.800
43%	43.2	30.0	30.4	0.4	0.818
47%	47.1	30.0	30.7	0.7	0.838
50%	50.1	30.0	30.3	0.3	0.856
53%	53.1	30.0	30.9	0.9	0.867
57%	57.0	30.0	30.9	0.9	0.879
60%	60.0	30.0	30.7	0.7	0.890
63%	63.1	30.0	30.8	0.8	0.899
67%	67.0	30.0	31.1	1.1	0.907
70%	69.9	30.0	31.0	1.0	0.914
75%	75.0	30.0	31.1	1.1	0.923
78%	78.0	30.0	30.8	0.8	0.930
80%	80.0	30.0	31.0	1.0	0.932
84%	84.3	30.0	31.1	1.1	0.938
89%	89.1	30.0	31.2	1.2	0.944
94%	93.6	30.0	31.0	1.0	0.949
97%	96.5	<30	25.2	--	0.968
100%	98.6	<30	14.5	--	0.989

Rectangular Curve ($Q=30.0\%S_n$ / Capacitive)					
P Desired (%Sn)	P measured (%Sn)	Q desired (%Sn)	Q measured (%Sn)	Q Deviation (%Sn)	Power Factor (cos ϕ)
0%	0.1	<10(*)	4.2 (*)	--	0.026
3%	3.5	<10(*)	3.4 (*)	--	0.766
8%	8.5	<10(*)	2.3 (*)	--	0.965
10%	10.5	<10(*)	-2.2(*)	--	-0.980
15%	15.4	<10(*)	-4.9(*)	--	-0.952
18%	18.3	<30(*)	-8.2(*)	--	-0.912
20%	20.6	<30(*)	-11.2(*)	--	-0.878

NRS 097-2-1: 2017 Edition 2

25%	25.1	30.0	-29.6	0.4	-0.647
28%	28.2	30.0	-29.1	0.9	-0.696
30%	30.1	30.0	-29.9	0.1	-0.710
33%	33.1	30.0	-29.4	0.6	-0.747
37%	37.1	30.0	-29.9	0.1	-0.778
40%	40.2	30.0	-29.6	0.4	-0.805
43%	43.0	30.0	-29.5	0.5	-0.825
47%	47.2	30.0	-29.1	0.9	-0.851
50%	50.3	30.0	-29.4	0.6	-0.863
53%	53.0	30.0	-29.2	0.8	-0.876
57%	57.1	30.0	-29.2	0.8	-0.891
60%	60.1	30.0	-29.3	0.7	-0.899
63%	62.9	30.0	-29.3	0.7	-0.907
67%	66.8	30.0	-29.1	0.9	-0.917
70%	70.1	30.0	-28.9	1.1	-0.924
75%	74.9	30.0	-29.1	0.9	-0.932
78%	77.9	30.0	-29.1	0.9	-0.937
80%	80.0	30.0	-28.8	1.2	-0.941
84%	83.9	30.0	-29.0	1.0	-0.945
89%	89.2	30.0	-29.0	1.0	-0.951
94%	93.7	30.0	-28.6	1.4	-0.956
97%	97.7	<30	-23.4	--	-0.973
99%	98.6	<30	-13.1	--	-0.991
100%	100.0	<30	-7.1	--	-0.997

(*) When operating in this mode for all inverter current outputs below 25% of rated current, it is acceptable for the displacement power factor to be controlled such that the vars supplied or drawn are less than the amount of vars supplied or drawn at 25% current output.

NRS 097-2-1: 2017 Edition 2

Test results are represented at diagrams below.

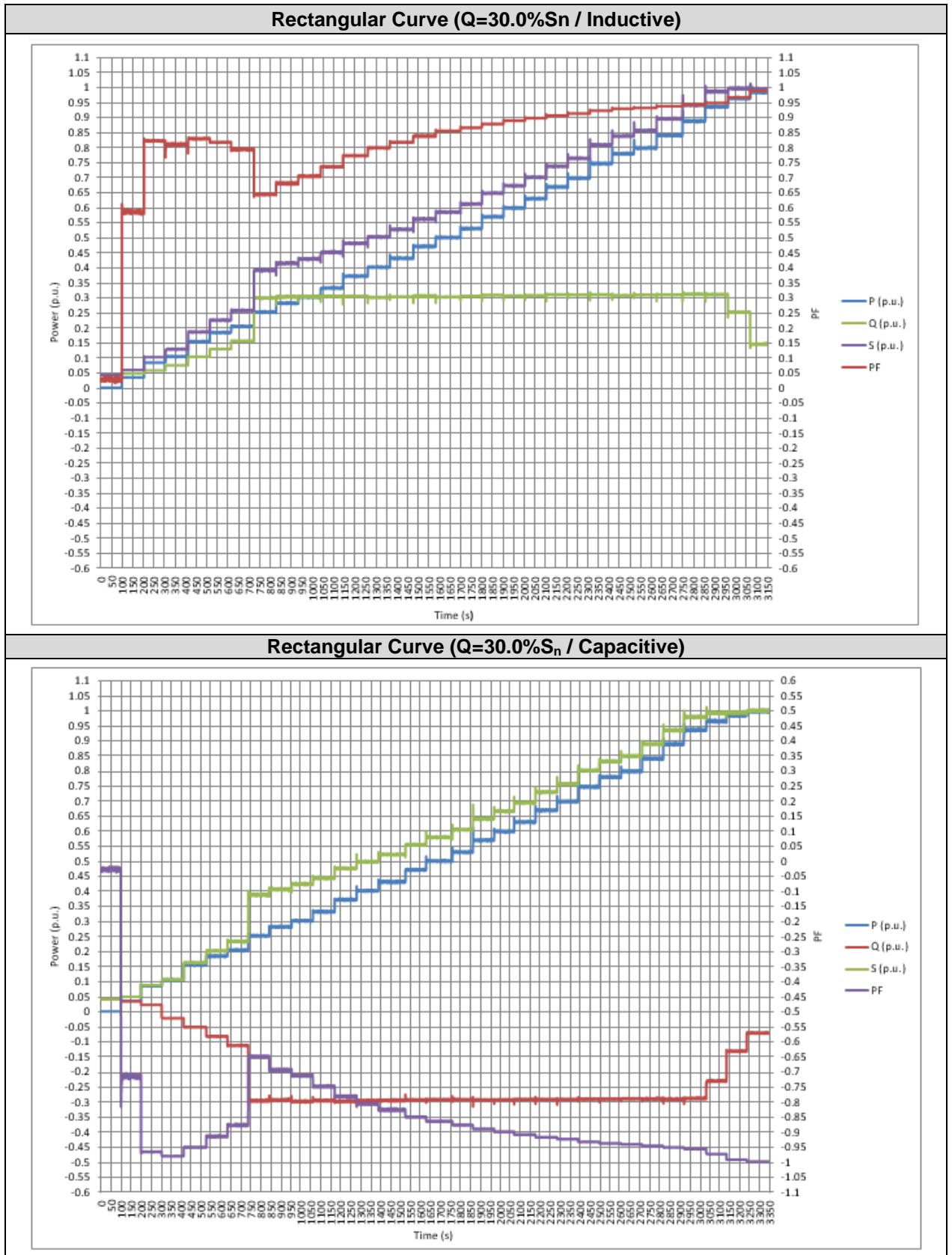

Rectangular Curve (Capacitive vs Inductive)

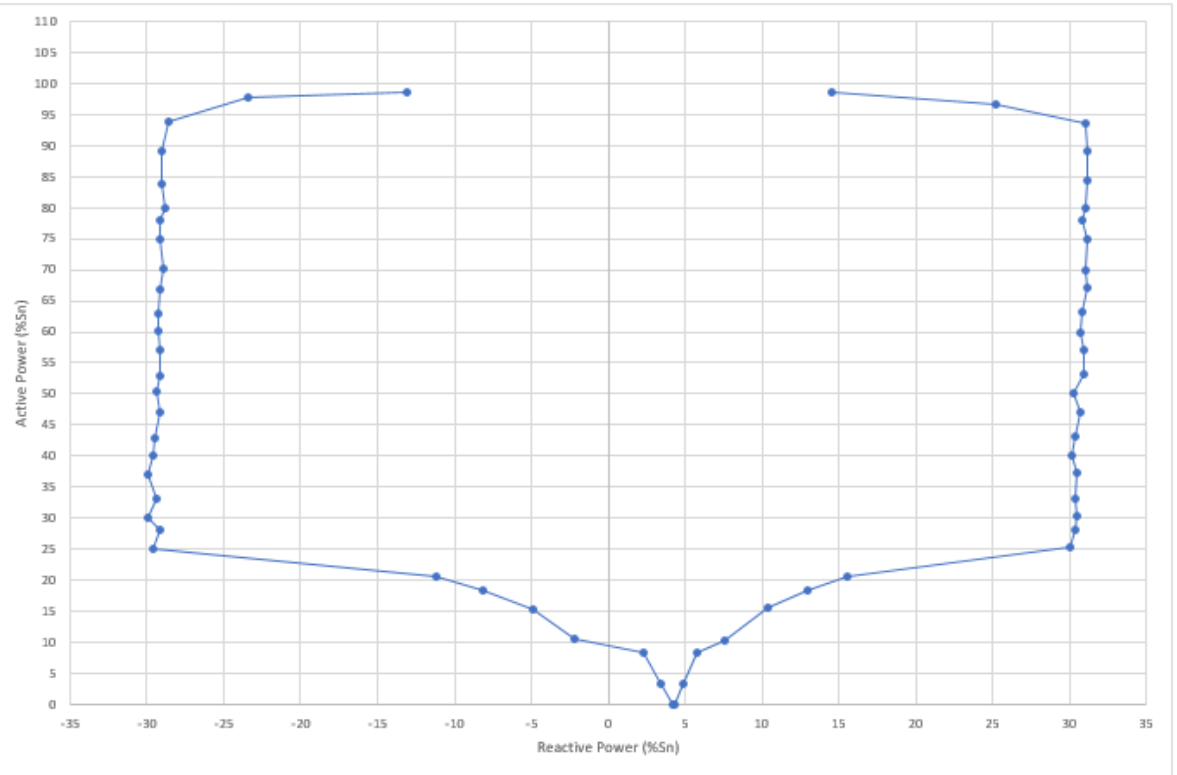

NRS 097-2-1: 2017 Edition 2

The following table and graphs show test results for measurements of power factor set to 0.80 inductive:

Unity Power Factor (PF=0.80 / Inductive)					
P Desired (%Sn)	P measured (%Sn)	Q measured (%Sn)	Power Factor desired (cos φ)	Power Factor measured (cos φ)	Power Factor Deviation (cos φ)
3%	3.5	4.4	0.800	0.627	-0.173
8%	8.4	8.5	0.800	0.706	-0.094
10%	10.5	9.3	0.800	0.748	-0.052
15%	15.4	11.4	0.800	0.804	0.004
18%	18.4	12.5	0.800	0.828	0.028
20%	20.5	16.5	0.800	0.779	-0.021
25%	25.5	19.1	0.800	0.800	0.000
28%	28.6	21.6	0.800	0.798	-0.002
30%	30.4	23.0	0.800	0.798	-0.002
33%	33.4	25.0	0.800	0.800	0.000
37%	37.2	27.8	0.800	0.801	0.001
40%	40.3	30.2	0.800	0.800	0.000
43%	43.3	32.6	0.800	0.799	-0.001
47%	47.0	35.4	0.800	0.799	-0.001
50%	50.0	37.9	0.800	0.797	-0.003
53%	52.9	40.1	0.800	0.797	-0.003
57%	56.7	42.9	0.800	0.797	-0.003
60%	59.7	44.8	0.800	0.800	0.000
63%	62.8	46.9	0.800	0.801	0.001
67%	66.5	49.9	0.800	0.800	0.000
70%	69.5	52.2	0.800	0.800	0.000
75%	74.0	55.5	0.800	0.800	0.000
78%	77.6	57.9	0.800	0.801	0.001
80%	79.1	59.6	0.800	0.799	-0.001
84%	83.8	54.2	0.800	0.840(*)	0.040
87%	86.6	49.3	0.800	0.869(*)	0.069
90%	89.9	44.1	0.800	0.898(*)	0.098
92%	90.0	44.1	0.800	0.898(*)	0.098
94%	92.1	39.8	0.800	0.918(*)	0.118
96%	93.6	34.1	0.800	0.940(*)	0.140
98%	95.4	28.7	0.800	0.958(*)	0.158
100%	98.0	21.2	0.800	0.977(*)	0.177

(*) The inverter does not reach the fixed power factor value of 0.8 due to the current limitation function.

NRS 097-2-1: 2017 Edition 2

The following table and graphs show test results for measurements of power factor set to 0.80 capacitive:

Unity Power Factor (PF=0.80 / Capacitive)					
P Desired (%Sn)	P measured (%Sn)	Q measured (%Sn)	Power Factor desired (cos φ)	Power Factor measured (cos φ)	Power Factor Deviation (cos φ)
3%	3.5	3.9	0.800	0.671	-0.129
8%	8.4	-2.6	0.800	0.955	0.155
10%	10.6	-5.2	0.800	0.898	0.098
15%	15.5	-9.0	0.800	0.865	0.065
18%	18.5	-11.8	0.800	0.842	0.042
20%	20.2	-13.8	0.800	0.826	0.026
25%	25.4	-18.8	0.800	0.804	0.004
28%	28.5	-21.3	0.800	0.801	0.001
30%	30.3	-22.4	0.800	0.804	0.004
33%	33.2	-25.3	0.800	0.796	-0.004
37%	37.2	-27.8	0.800	0.801	0.001
40%	40.0	-30.1	0.800	0.799	-0.001
43%	42.7	-32.2	0.800	0.799	-0.001
47%	46.9	-35.4	0.800	0.798	-0.002
50%	49.9	-37.6	0.800	0.799	-0.001
53%	52.5	-39.8	0.800	0.797	-0.003
57%	56.4	-42.1	0.800	0.801	0.001
60%	60.4	-44.9	0.800	0.802	0.002
63%	63.4	-47.6	0.800	0.800	0.000
67%	67.0	-50.7	0.800	0.798	-0.002
70%	69.8	-52.7	0.800	0.798	-0.002
75%	74.7	-56.0	0.800	0.800	0.000
78%	78.4	-58.3	0.800	0.802	0.002
80%	80.2	-59.7	0.800	0.802	0.002
84%	83.3	-54.0	0.800	0.839(*)	0.039
87%	86.6	-48.9	0.800	0.870(*)	0.070
90%	89.8	-43.5	0.800	0.900(*)	0.100
92%	91.4	-38.9	0.800	0.920(*)	0.120
94%	93.3	-33.6	0.800	0.941(*)	0.141
96%	95.3	-27.5	0.800	0.961(*)	0.161
98%	97.7	-18.9	0.800	0.982(*)	0.182
100%	99.8	-6.7	0.800	0.998(*)	0.198

(*) The inverter does not reach the fixed power factor value of 0.8 due to the current limitation function.

NRS 097-2-1: 2017 Edition 2

Triangular Curve (PF=0.80 / Inductive)

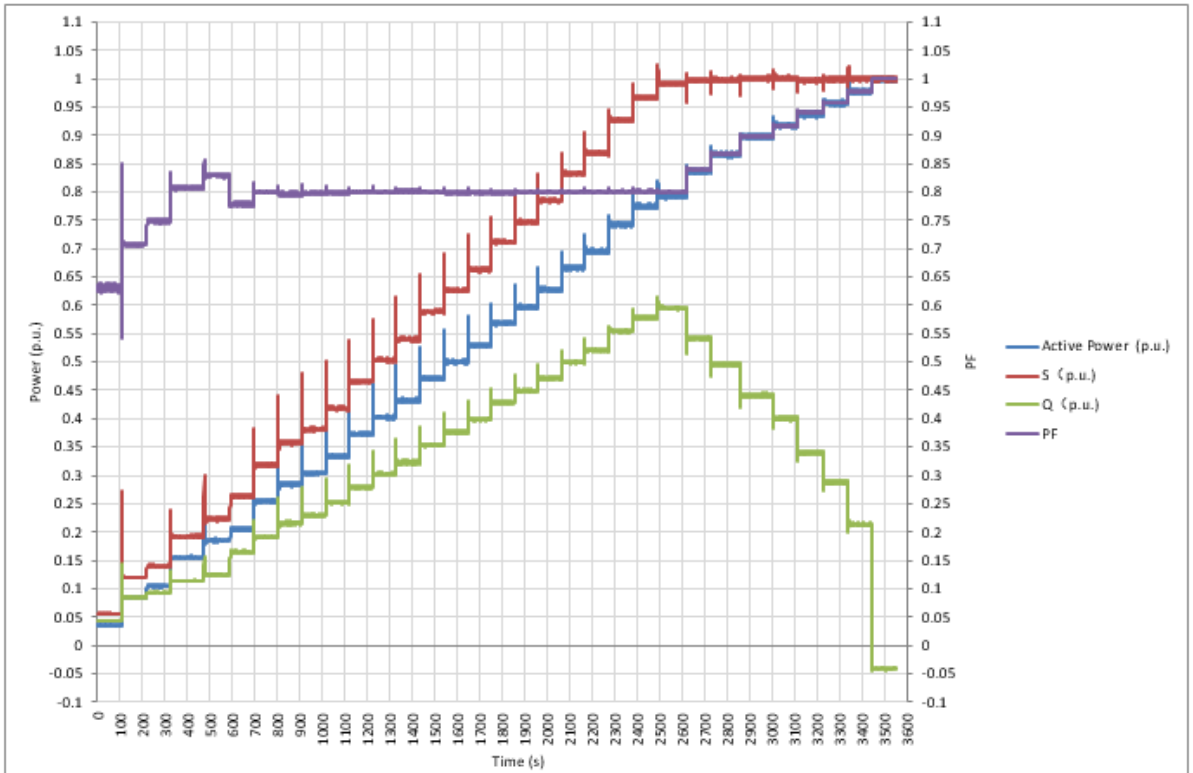

Triangular Curve (PF=0.8 / Capacitive)

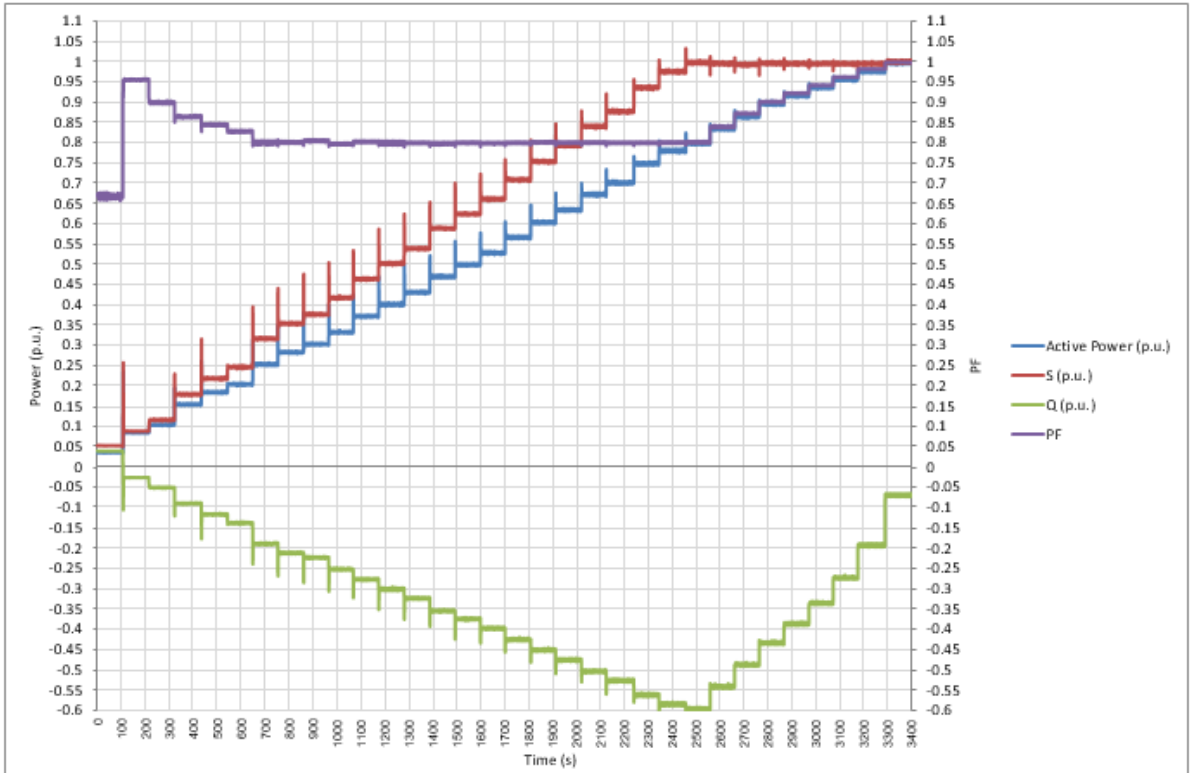

Triangular Curve (Inductive vs Capacitive)

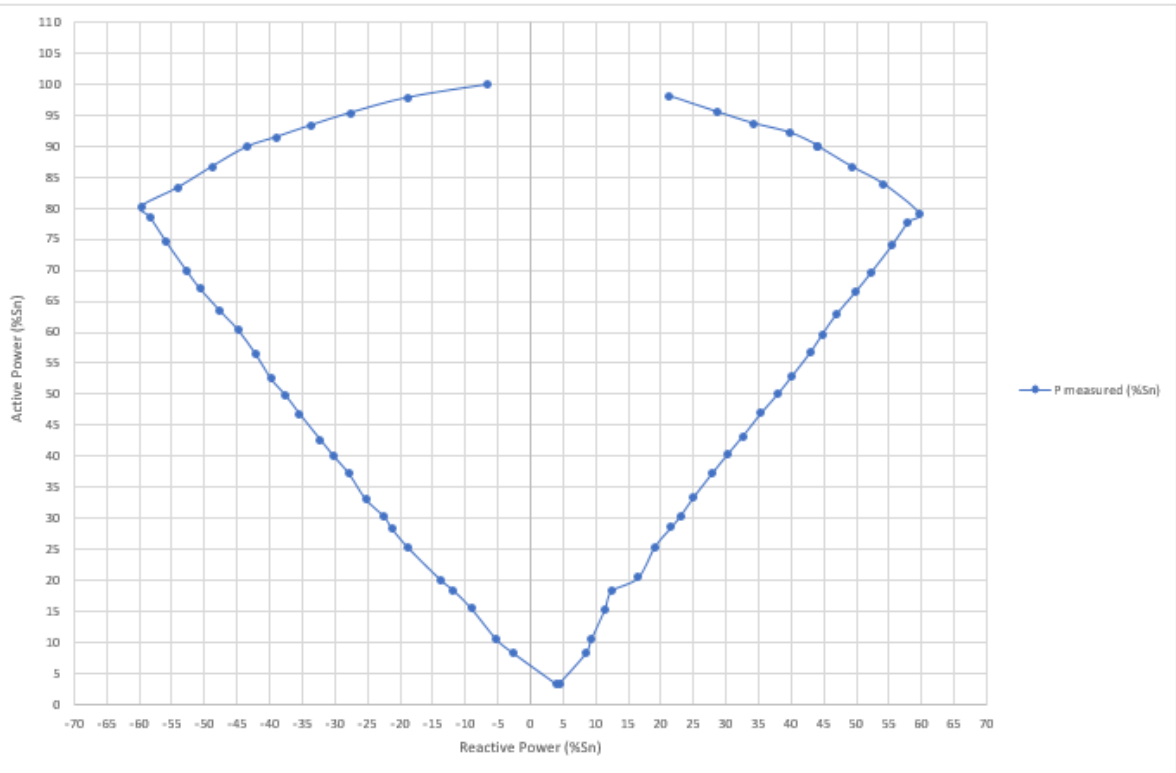

4.9.3 Test 3: Triangular Curve (PF=±0.8)

This test verifies the capability of the inverter to provide a fixed value of power factor. In addition it is verified the PF control mode.

At high active power levels the reactive power provided by the inverter is automatically limited by the inverter in order to protect against over current.

The maximum tolerance allowed for the measured Power Factor is ± 0.01, for measurements from 25%Sn.

The following table shows the test results:

Triangular Curve (PF=0.8 / Inductive)					
P Desired (%Sn)	P measured (%Sn)	Q measured (%Sn)	Power Factor desired (cos φ)	Power Factor measured (cos φ)	Power Factor Deviation (cos φ)
3%	3.6	4.4	--	--	--
8%	8.5	8.5	--	--	--
10%	10.5	9.3	--	--	--
15%	15.5	11.3	--	--	--
18%	18.4	12.6	--	--	--
20%	20.6	16.5	--	--	--
25%	25.5	19.1	0.800	0.800	0.000
28%	28.4	21.7	0.800	0.794	-0.006
30%	30.6	23.1	0.800	0.798	-0.002
33%	33.4	25.0	0.800	0.800	0.000
37%	37.2	27.9	0.800	0.801	0.001
40%	40.7	30.3	0.800	0.802	0.002
43%	43.0	32.2	0.800	0.800	0.000
47%	46.6	34.4	0.800	0.804	0.004
50%	50.0	37.9	0.800	0.797	-0.003
53%	53.1	40.1	0.800	0.798	-0.002
57%	57.0	42.9	0.800	0.799	-0.001
60%	59.8	44.8	0.800	0.800	0.000
63%	62.6	47.2	0.800	0.799	-0.001
67%	66.8	49.9	0.800	0.801	0.001
70%	69.4	52.3	0.800	0.799	-0.001
75%	74.5	55.3	0.800	0.803	0.003
78%	77.1	57.9	0.800	0.800	0.000
80%	79.5	59.4	0.800	0.801	0.001
84%	83.7	54.3	0.800	0.839	0.039
87%	86.7	49.4	0.800	0.869	0.069
90%	89.5	44.1	0.800	0.897	0.097
92%	91.5	39.7	0.800	0.917	0.117
94%	93.9	34.1	0.800	0.940	0.140
96%	95.7	29.0	0.800	0.957	0.157
98%	97.9	21.2	0.800	0.977	0.177
100%	99.7	-4.1	0.800	0.999	0.199

NRS 097-2-1: 2017 Edition 2

Triangular Curve (PF=0.8 / Capacitive)					
P Desired (%Sn)	P measured (%Sn)	Q measured (%Sn)	Power Factor desired (cos φ)	Power Factor measured (cos φ)	Power Factor Deviation (cos φ)
3%	3.5	3.9	--	0.663	--
8%	8.5	-2.7	--	0.953	--
10%	10.3	-4.9	--	0.901	--
15%	15.6	-9.2	--	0.861	--
18%	17.6	-11.0	--	0.848	--
20%	20.7	-14.2	--	0.824	--
25%	25.3	-18.8	0.800	0.803	0.003
28%	28.1	-21.2	0.800	0.798	-0.002
30%	30.3	-22.4	0.800	0.804	0.004
33%	33.2	-25.1	0.800	0.797	-0.003
37%	37.1	-27.8	0.800	0.800	0.000
40%	40.2	-30.3	0.800	0.798	-0.002
43%	42.9	-32.5	0.800	0.797	-0.003
47%	46.8	-35.5	0.800	0.797	-0.003
50%	50.1	-37.5	0.800	0.800	0.000
53%	52.5	-39.8	0.800	0.797	-0.003
57%	56.8	-42.5	0.800	0.801	0.001
60%	60.1	-45.2	0.800	0.799	-0.001
63%	63.8	-47.6	0.800	0.801	0.001
67%	66.9	-50.5	0.800	0.798	-0.002
70%	70.3	-52.5	0.800	0.801	0.001
75%	74.5	-56.3	0.800	0.797	-0.003
78%	78.2	-58.2	0.800	0.802	0.002
80%	79.7	-60.1	0.800	0.798	-0.002
84%	83.2	-54.5	0.800	0.837	0.037
87%	86.8	-48.9	0.800	0.871	0.071
90%	89.7	-43.3	0.800	0.900	0.100
92%	91.3	-38.8	0.800	0.920	0.120
94%	93.5	-33.6	0.800	0.941	0.141
96%	95.7	-27.4	0.800	0.961	0.161
98%	97.6	-19.2	0.800	0.981	0.181
100%	99.8	-6.6	0.800	0.998	0.198

NRS 097-2-1: 2017 Edition 2

Test results are represented at the diagrams below.

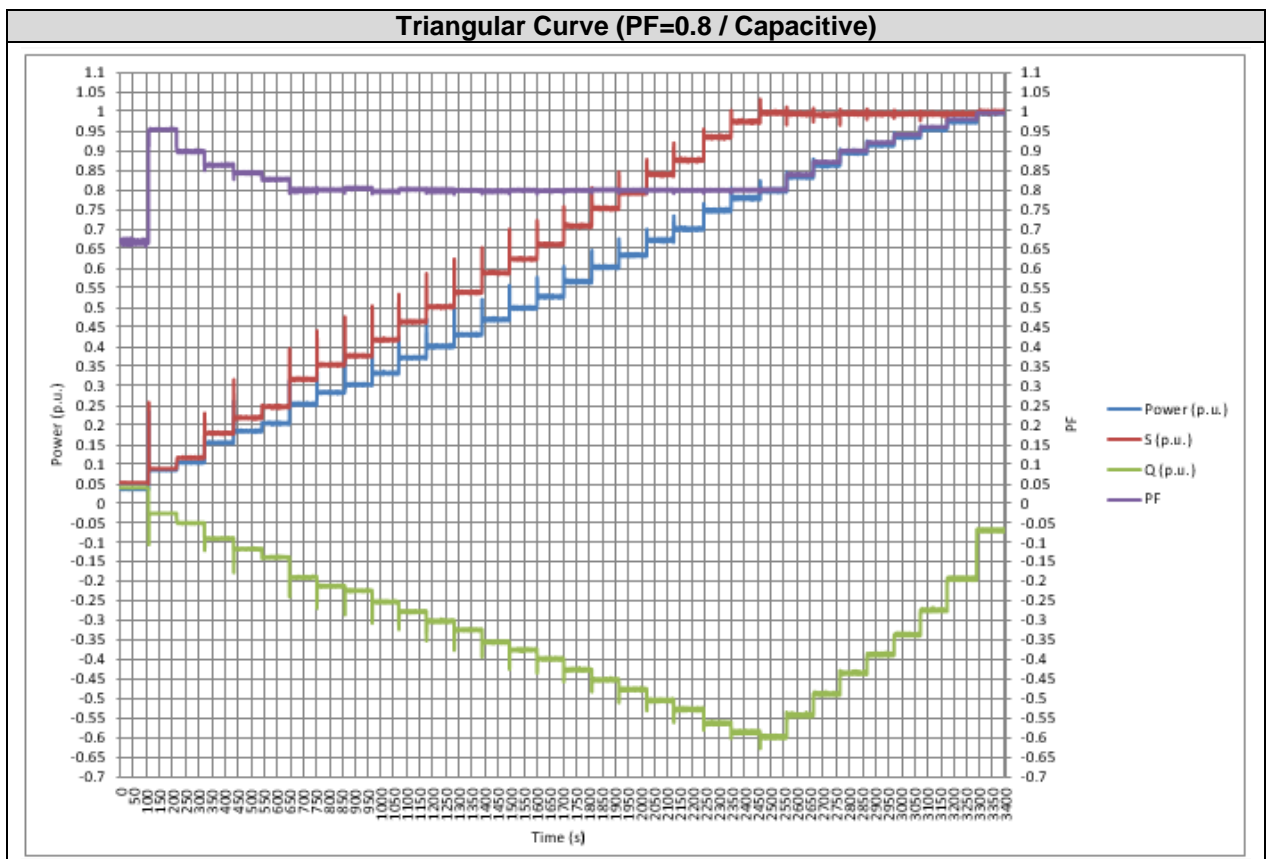
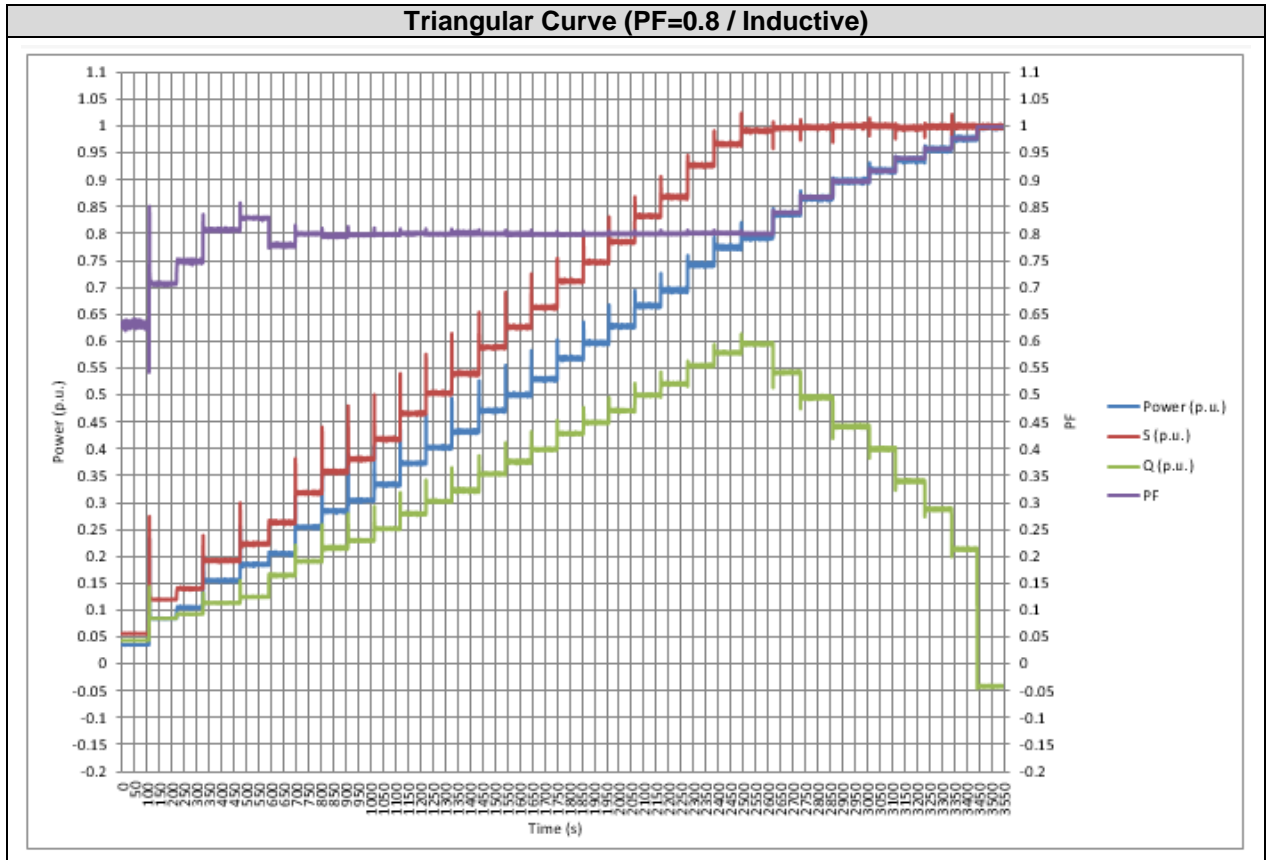

NRS 097-2-1: 2017 Edition 2

Triangular Curve (Inductive vs Capacitive)

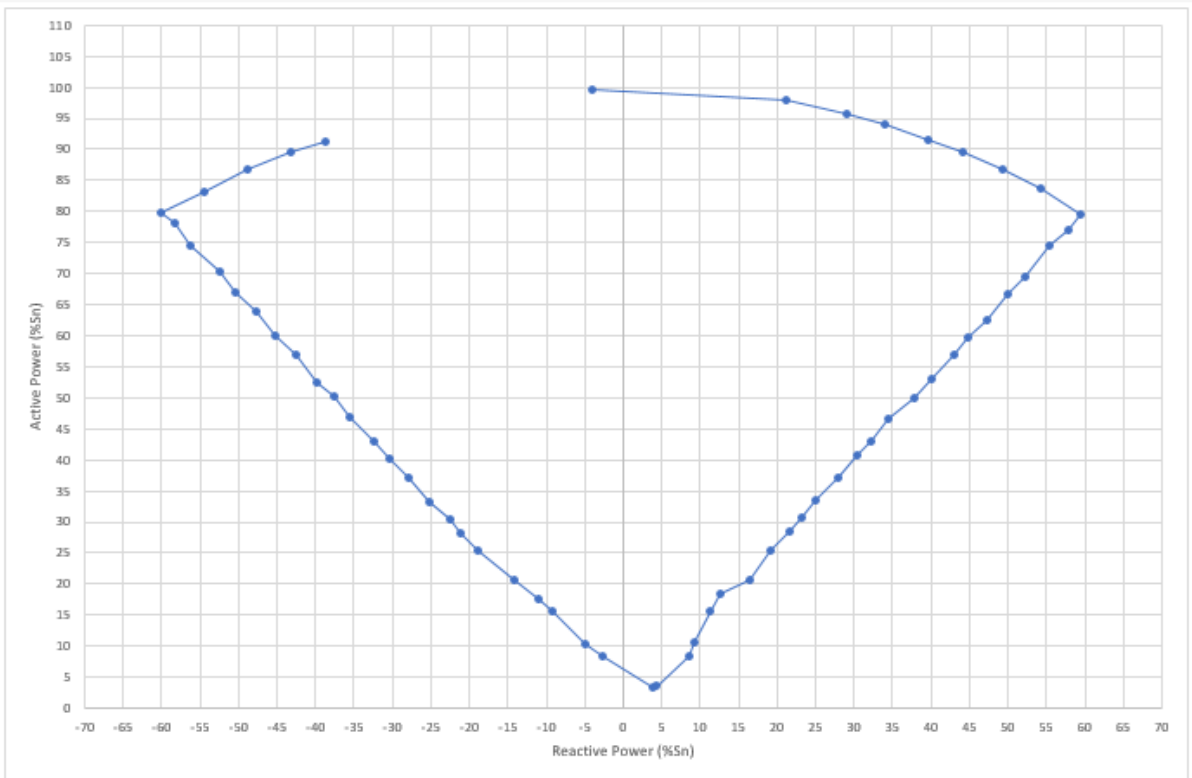

4.9.4 Test 4: Semicircular Curve (S=100%Sn)

This test verifies the capability of the inverter to provide a fixed value of apparent power.

Allowed tolerance for reactive power measurements is to be considered inside $\pm 5\%S_n$ when active power more than 25%

Test results are offered at the tables below.

Semicircular Curve (Inductive)						
P Desired (%Sn)	P measured (%Sn)	S measured (%Sn)	Power Factor (cos φ)	Q desired (%Sn)	Q measured (%Sn)	Q deviation (%Sn)
0%	0.1	99.8	0.001	100.0	99.8	-0.2
3%	3.5	99.8	0.035	100.0	99.7	-0.3
8%	8.5	99.8	0.085	99.7	99.4	-0.3
10%	10.4	99.6	0.104	99.5	99.1	-0.4
15%	15.4	99.8	0.155	98.9	98.6	-0.3
18%	18.4	99.8	0.184	98.4	98.1	-0.3
20%	20.4	100.2	0.204	98.0	98.1	0.1
25%	25.2	100.2	0.253	96.8	97.0	0.2
28%	28.2	100.2	0.282	96.0	96.1	0.1
30%	30.0	99.6	0.301	95.4	95.0	-0.4
33%	33.2	100.2	0.331	94.4	94.5	0.1
37%	37.0	99.6	0.372	92.9	92.5	-0.4
40%	40.0	99.8	0.401	91.7	91.4	-0.3
43%	43.0	100.0	0.430	90.3	90.3	0.0
47%	47.2	100.2	0.472	88.3	88.4	0.1
50%	50.0	100.2	0.499	86.6	86.8	0.2
53%	53.2	100.2	0.531	84.8	84.9	0.1
57%	57.0	99.8	0.572	82.2	81.9	-0.3
60%	60.0	100.0	0.600	80.0	80.0	0.0
63%	63.0	99.6	0.633	77.7	77.1	-0.6
67%	67.0	99.8	0.671	74.2	74.0	-0.2
70%	70.0	100.0	0.700	71.4	71.4	0.0
75%	74.8	99.6	0.751	66.1	65.8	-0.3
78%	78.2	100.0	0.781	62.6	62.3	-0.3
80%	80.0	99.6	0.802	60.0	59.3	-0.7
83%	84.0	99.8	0.840	55.8	53.9	-1.9
87%	88.4	100.0	0.885	49.3	46.7	-2.6
90%	89.0	99.8	0.890	43.6	45.2	1.6
94%	93.6	99.8	0.939	34.1	34.6	0.5
97%	96.6	100.0	0.967	24.3	25.9	1.6
100%	99.6	99.8	0.997	0.0	3.3	3.3

NRS 097-2-1: 2017 Edition 2

Semicircular Curve (Capacitive)						
P Desired (%Sn)	P measured (%Sn)	S measured (%Sn)	Power Factor (cos ϕ)	Q desired (%Sn)	Q measured (%Sn)	Q deviation (%Sn)
0%	0.1	99.8	0.001	-100.0	-99.6	0.4
3%	3.6	99.6	0.036	-100.0	-99.6	0.4
8%	8.4	99.5	0.084	-99.7	-99.2	0.5
10%	10.3	99.5	0.104	-99.5	-98.9	0.6
15%	15.4	99.5	0.154	-98.9	-98.3	0.6
18%	18.4	99.7	0.185	-98.4	-98.0	0.4
20%	20.4	99.6	0.205	-98.0	-97.5	0.5
25%	25.3	99.6	0.254	-96.8	-96.3	0.5
28%	28.3	99.7	0.284	-96.0	-95.6	0.4
30%	30.1	99.3	0.304	-95.4	-94.6	0.8
33%	33.2	99.5	0.334	-94.4	-93.8	0.6
37%	37.2	99.2	0.375	-92.9	-92.0	0.9
40%	40.1	99.2	0.404	-91.7	-90.8	0.9
43%	43.0	99.2	0.434	-90.3	-89.4	0.9
47%	47.1	99.3	0.474	-88.3	-87.4	0.9
50%	50.0	99.3	0.503	-86.6	-85.8	0.8
53%	52.9	99.3	0.532	-84.8	-84.1	0.7
57%	56.8	100.1	0.568	-82.2	-82.4	-0.2
60%	60.0	99.8	0.601	-80.0	-79.8	0.2
63%	63.3	99.6	0.635	-77.7	-76.9	0.8
67%	67.3	99.2	0.679	-74.2	-72.8	1.4
70%	70.0	98.9	0.707	-71.4	-69.9	1.5
75%	75.1	99.6	0.754	-66.1	-65.4	0.7
78%	78.0	99.3	0.785	-62.6	-61.5	1.1
80%	80.1	99.7	0.803	-60.0	-59.4	0.6
83%	83.1	99.3	0.837	-55.8	-54.3	1.5
87%	86.6	100.1	0.865	-49.3	-50.3	-1.0
90%	89.9	100.0	0.899	-43.6	-43.7	-0.1
94%	93.8	99.5	0.943	-34.1	-33.1	1.0
97%	97.4	99.3	0.980	-24.3	-19.6	4.7
100%	99.9	100.1	0.998	0.0	-3.5	-3.5

NRS 097-2-1: 2017 Edition 2

Test results are represented at the diagrams below.

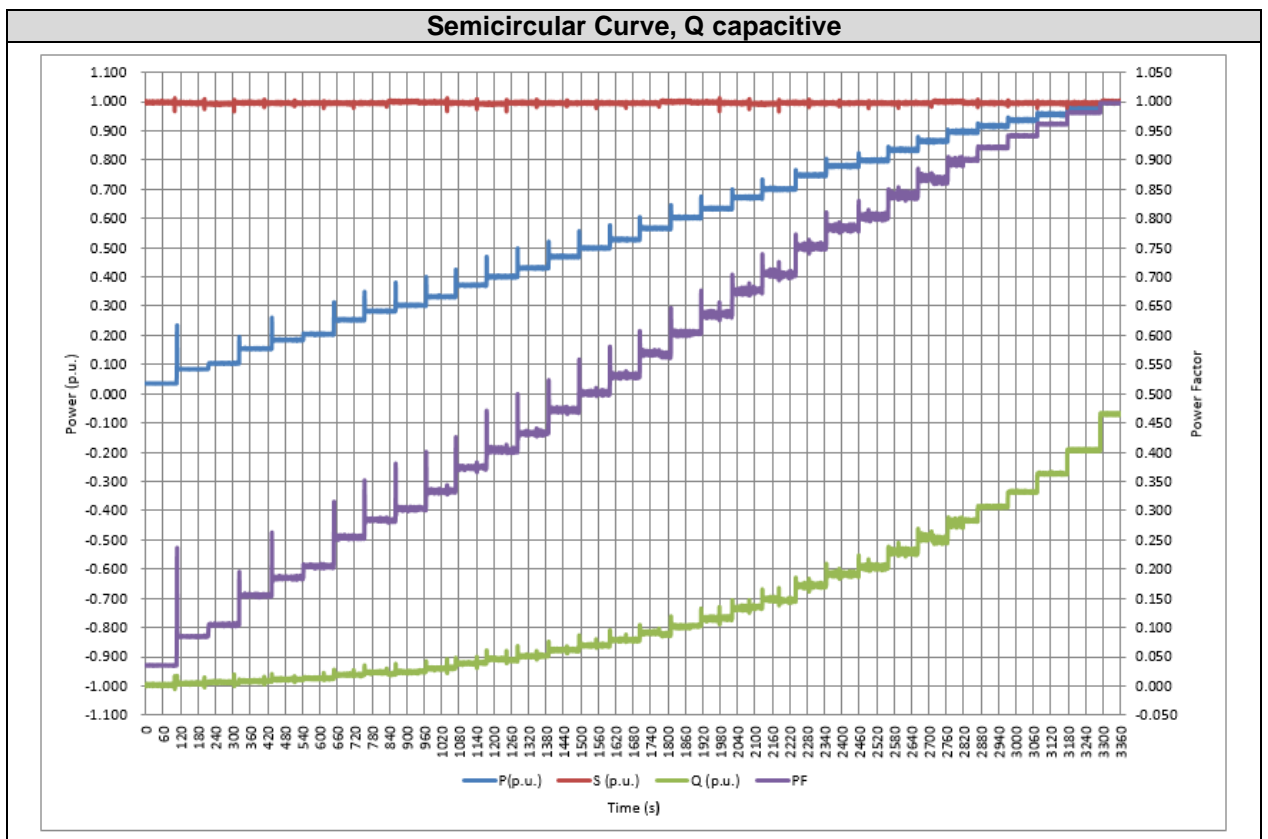
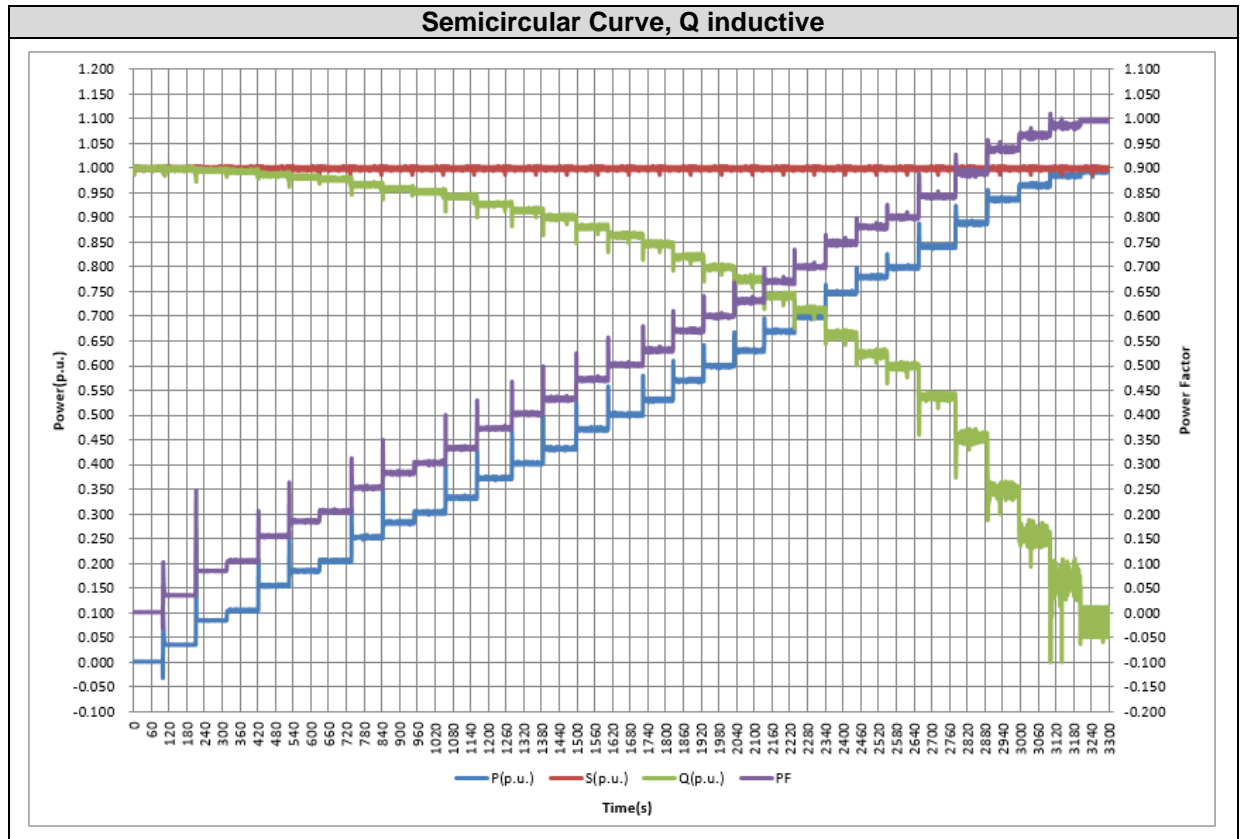

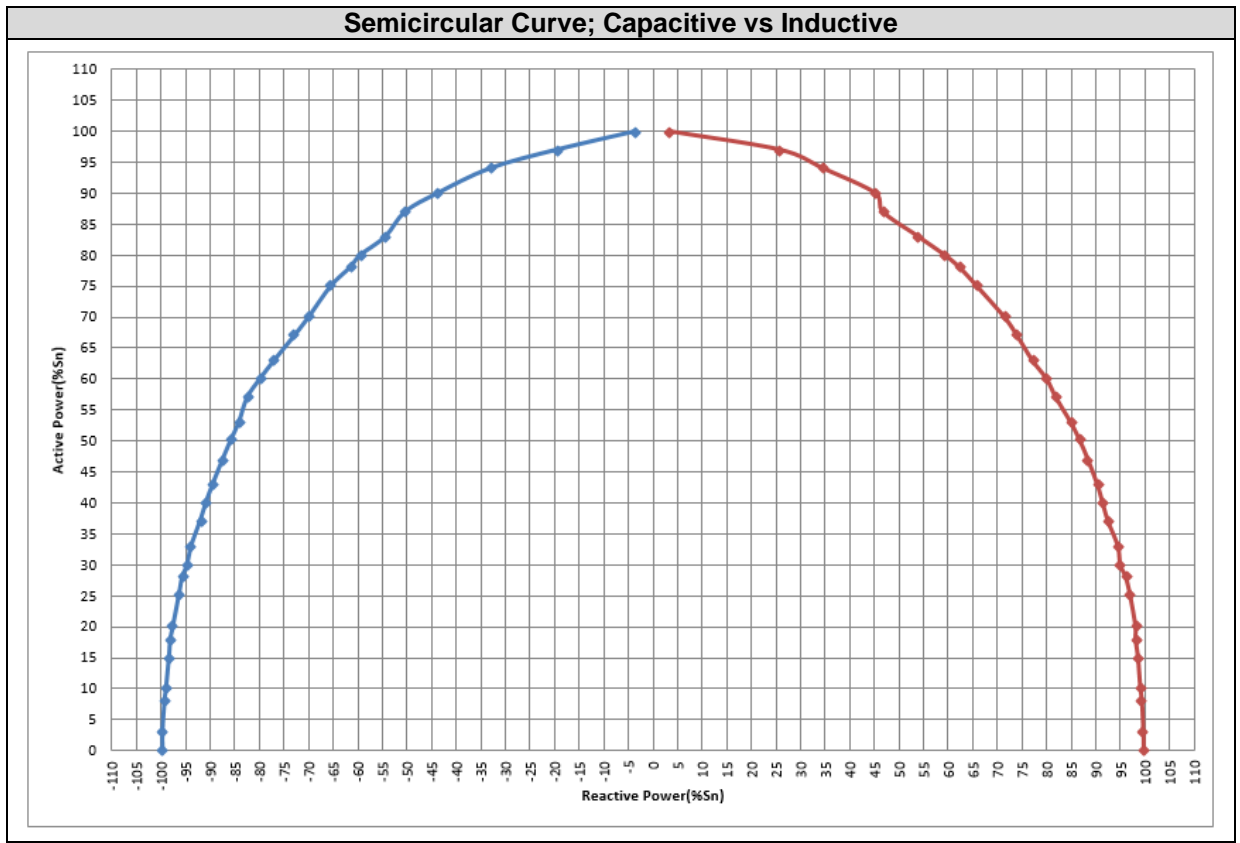

4.9.5 Test 5: Settable to operate according to a characteristic curve

It has also to be verified the capability of the inverter for providing a fixed value of the power factor in function of the active power according to the next picture:

0.9 leading to 0.9 lagging is more restrictive than 0.95 as the standard required.

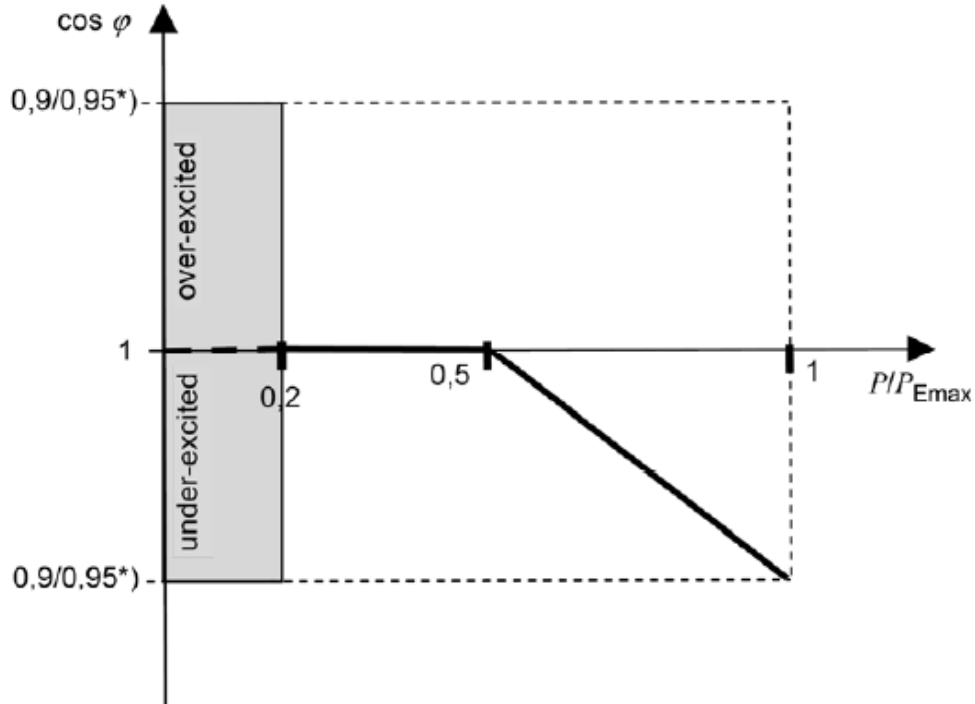

The results are offered in the table below (Note: 10%Pn have not measured in following test):

Setting $\cos \varphi(P)$ with the standard characteristic curve (20%Pn to 100%Pn)						
Active Power Setting (% P_{Emax})	Active Power Measured (p.u.)	Reactive Power Measured (p.u.)	$\cos \varphi$ Measured	Desired $\cos \varphi$	$\Delta \cos \varphi$ (<0,01)	Transient period (<10s)
20	0.203	0.012	0.998	1.000	-0.002	0.4s
30	0.303	0.015	0.999	1.000	-0.001	0.4s
40	0.408	0.016	0.999	1.000	-0.001	0.3s
50	0.507	0.018	0.999	1.000	-0.001	0.4s
60	0.601	0.119	0.981	0.980	0.001	0.4s
70	0.702	0.207	0.959	0.960	-0.001	0.4s
80	0.803	0.291	0.940	0.940	0.000	0.3s
90	0.902	0.382	0.921	0.920	0.001	0.4s
100(*)	0.904	0.439	0.899	0.900	-0.001	0.3s

(*) Because of limited by apparent power, the active does not reach to 100% when $\cos \varphi = 0.9$

Setting $\cos \phi(P)$ with standard characteristic curve (20%Pn to 100%Pn)

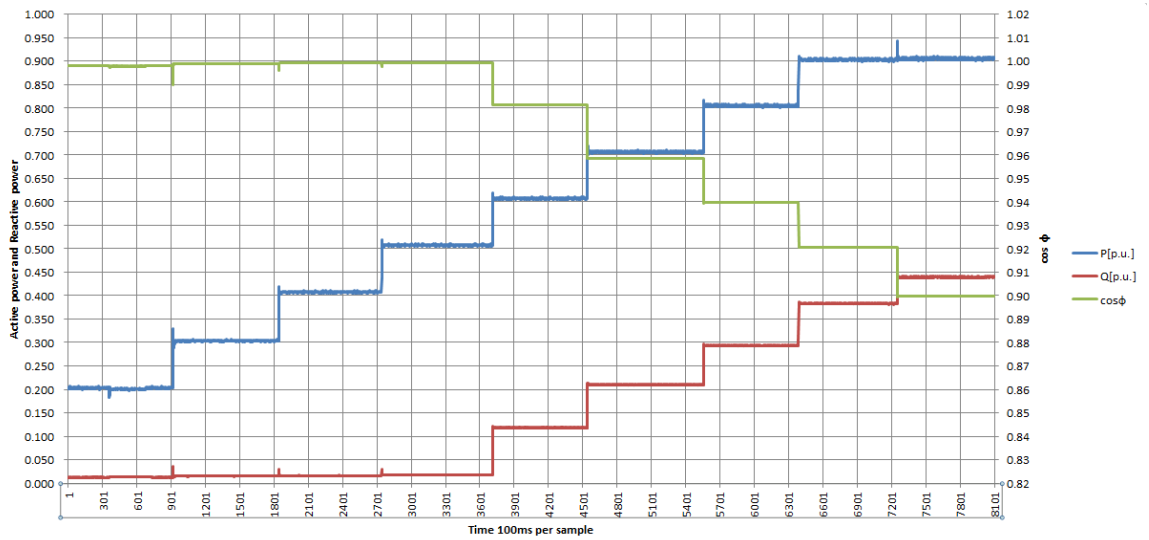

4.10 SYNCHRONIZATION AND RESPONSE TO UTILITY RECOVERY

Synchronization have been measured according to Clause 4.1.12 and Clause 4.2.4 of the standard.

The embedded generator shall ensure synchronisation before re-energizing at all times.

After a voltage or frequency out-of-range condition that has caused the embedded generator to cease energizing the utility network, the generator shall not re-energize the utility network until the utility service voltage and frequency have remained within the specified ranges for a continuous and uninterrupted period of 60 s.

Controllable generators may reconnect immediately after the 60 s delay confirming recovery of the system voltage and frequency at a maximum rate of 10 % of rated power per minute, i.e. full power output will only be reached after 10 minutes.

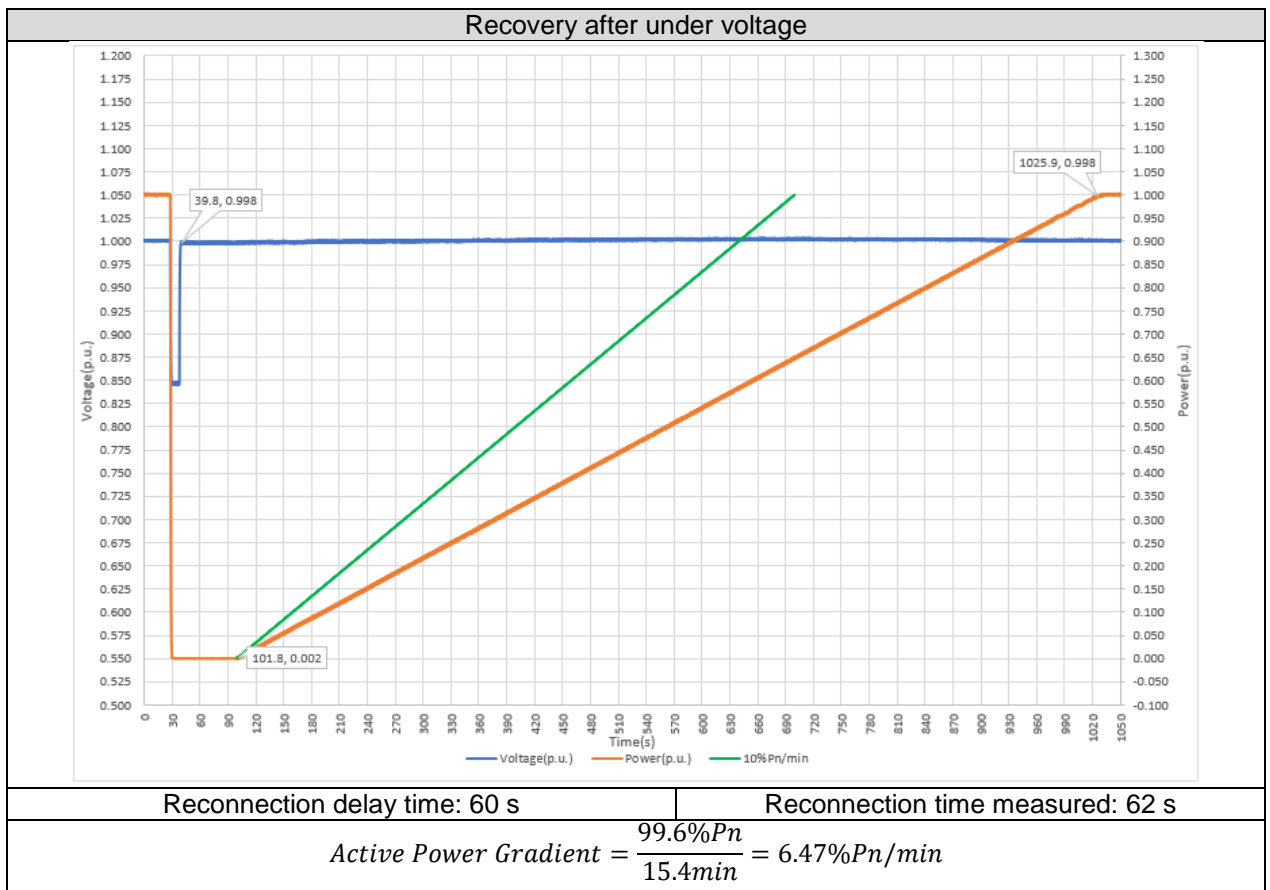

Recovery after Over voltage

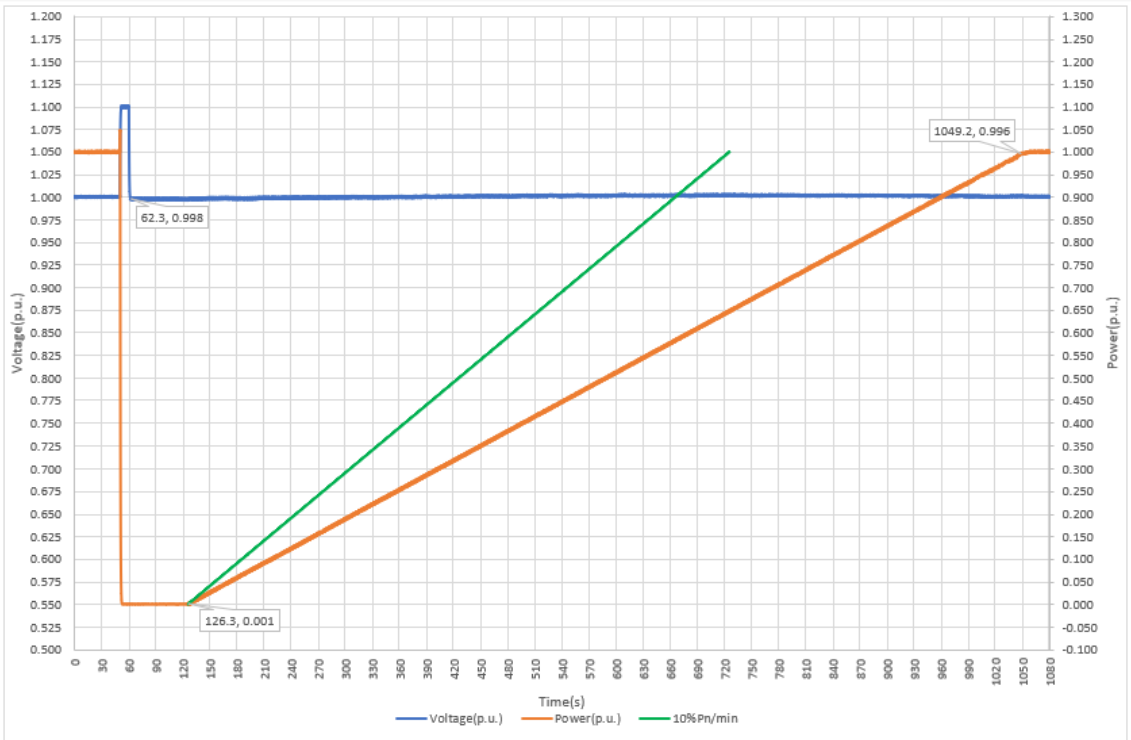

Reconnection delay time: 60 s

Reconnection time measured: 64 s

$$\text{Active Power Gradient} = \frac{99.5\%P_n}{15.4\text{min}} = 6.46\%P_n/\text{min}$$

Recovery after Under frequency

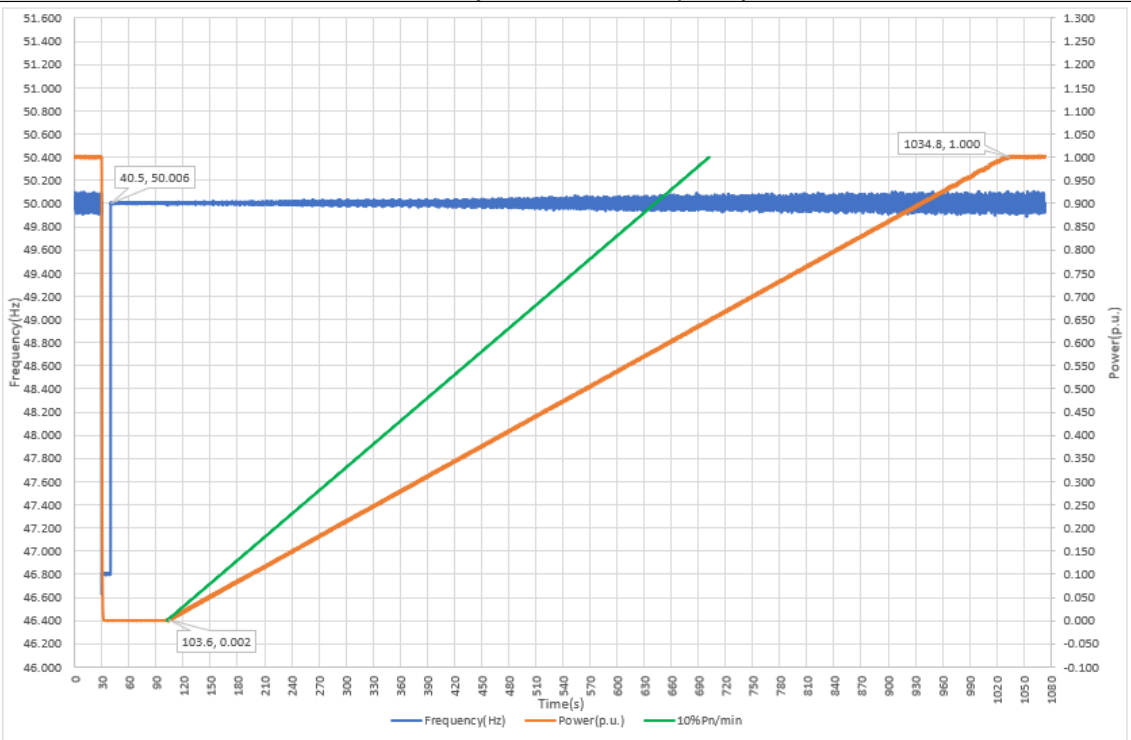

Reconnection delay time: 60 s

Reconnection time measured: 63 s

$$\text{Active Power Gradient} = \frac{99.8\%P_n}{15.5\text{min}} = 6.44\%P_n/\text{min}$$

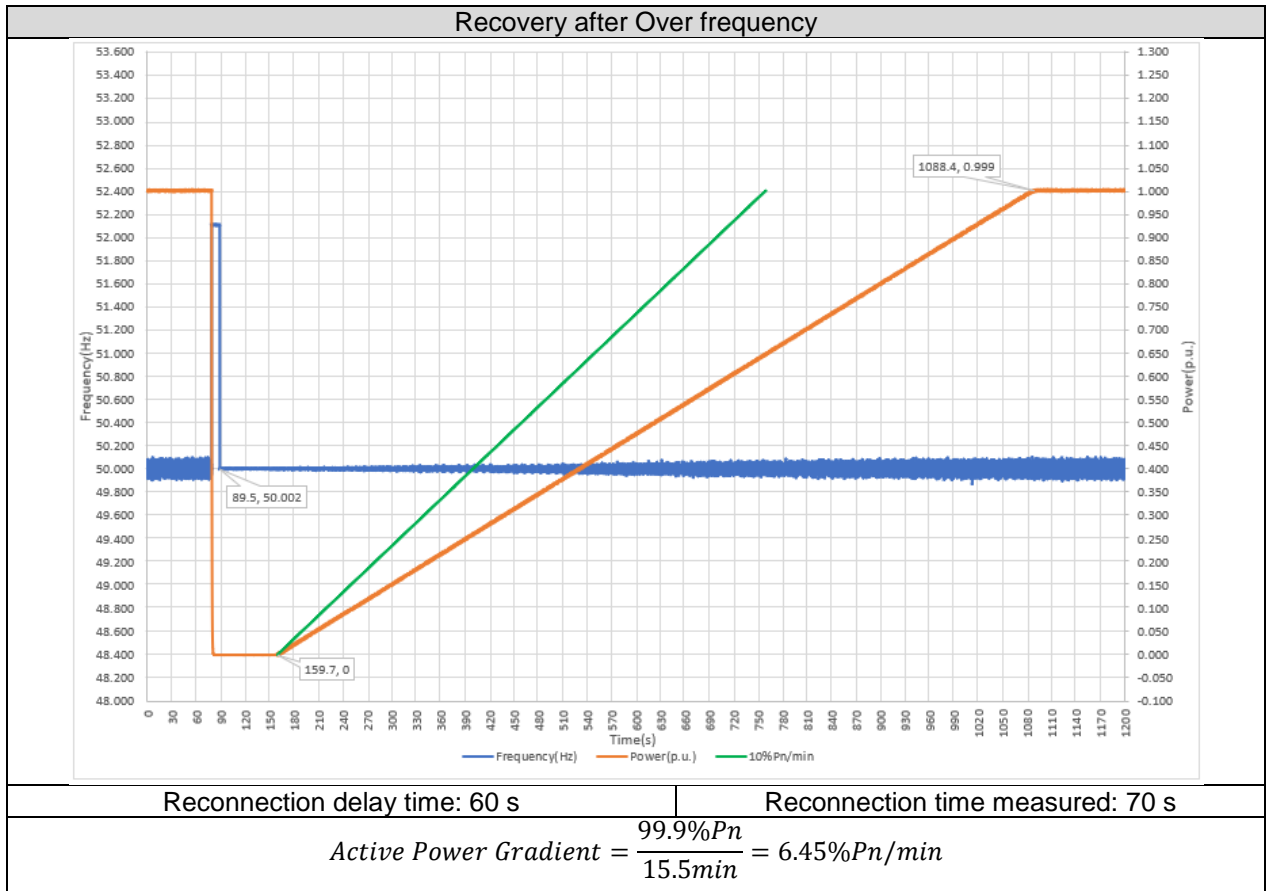

4.11 ELECTROMAGNETIC COMPATIBILITY (EMC)

Synchronization have been measured according to Clause 4.1.13 of the standard.

This Clause will be considered in EMC report.

4.12 MAINS SIGNALLING (E.G. PLC AND RIPPLE CONTROL)

Synchronization have been considered according to Clause 4.1.14 of the standard.

The EUT is not use PLC-based communication. This clause is not applicable.

4.13 SAFETY DISCONNECT FROM UTILITY NETWORK

Synchronization have been considered according to Clause 4.2.2 of the standard.

The safety requirements in accordance with IEC 62109-1:2010 and IEC 62109-2:2011.

The compliances with these requirements are stated in the following test report:

- Test report n° SHES190301262471, SHES190301262472 on 28/03/2019

4.13.1 *Disconnection device (previously disconnection switching unit)*

Disconnection device have been considered according to Clause 4.2.2.2 of the standard

The output is switched off redundant by two relays in serial on both line and neutral. This assures that the opening of the output circuit can operate in case of single fault.

4.13.2 Overvoltage and undervoltage

Disconnection device have been considered according to Clause 4.2.2.3.2 of the standard

The accuracy for voltage trip values shall be within 0 % to +1 % of the nominal voltage from the upper boundary trip setting, and within -1% to 0% of the nominal voltage from the lower boundary trip setting.

The disconnection time should comply with following table:

1	2
Voltage range (at point of connection)	Maximum trip time S
V < 50 %	0,2 s
50 % ≤ V < 85 %	10 s
85 % ≤ V ≤ 110 %	Continuous operation
110 % < V < 115 %	40 s
115% ≤ V < 120%	2 s
120 % ≤ V	0,16 s
NOTE If multi-voltage control settings are not possible, the more stringent trip time should be implemented, e.g. 2 s between 110% and 120% of voltage.	

The following table shows the test results:

Voltage level	Voltage Setting (p.u.)	Voltage Trip (p.u.)	Deviation (within ±0.01)	Trip time limit (ms)	Time measured (ms)
U < 50% Un	0.500	0.497	-0.003	200	35
U < 85% Un	0.850	0.846	-0.004	10000	213
U > 110% Un	1.100	110.4	0.004	40000	229
U > 115% Un	1.150	1.156	0.006	2000	169
U > 120% Un	1.200	1.205	0.005	160	37

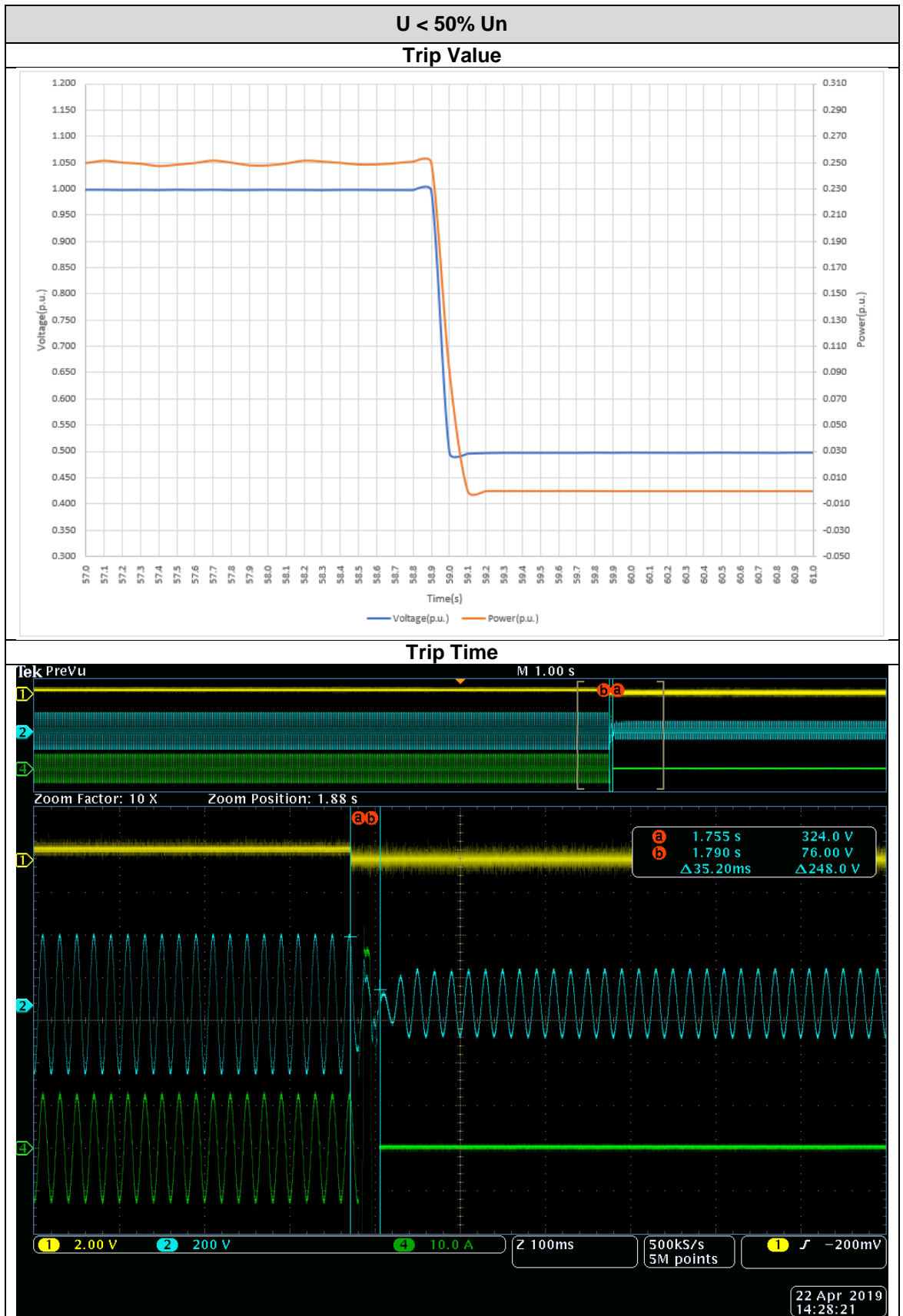

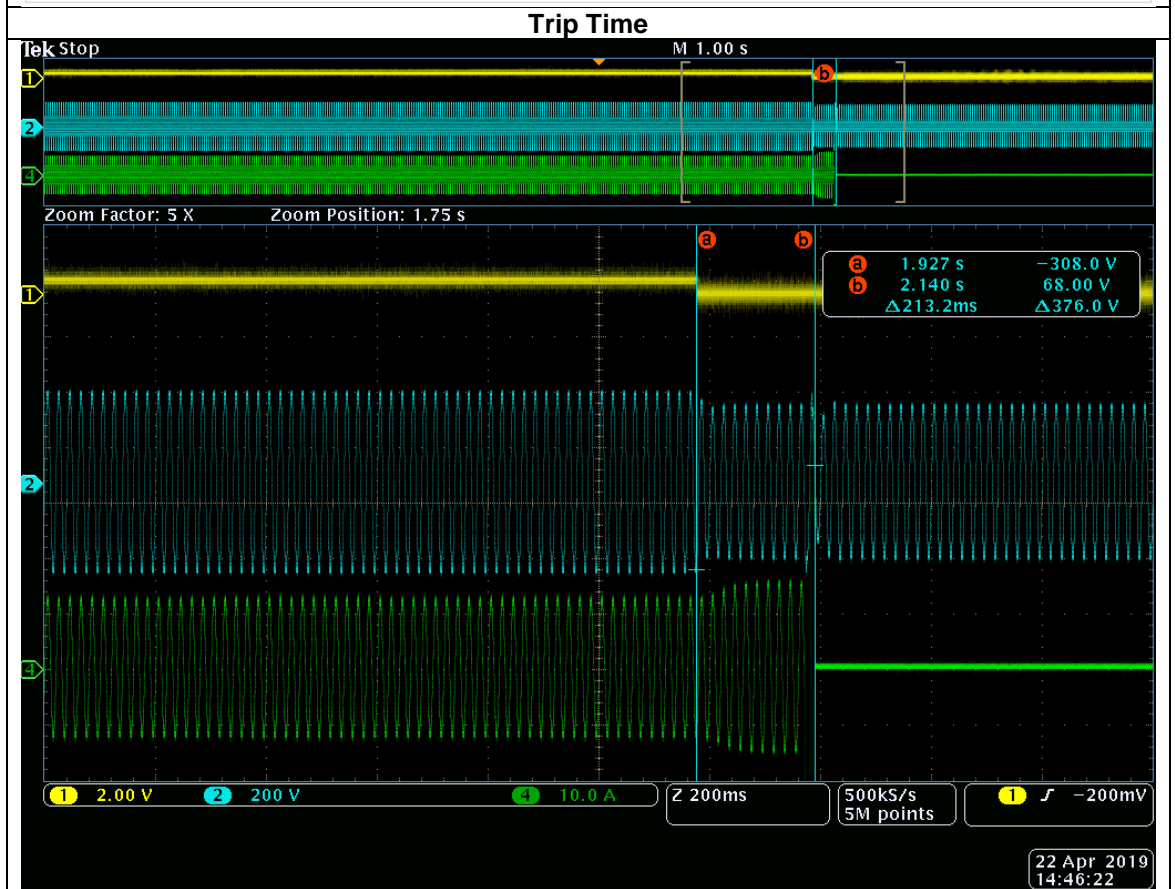
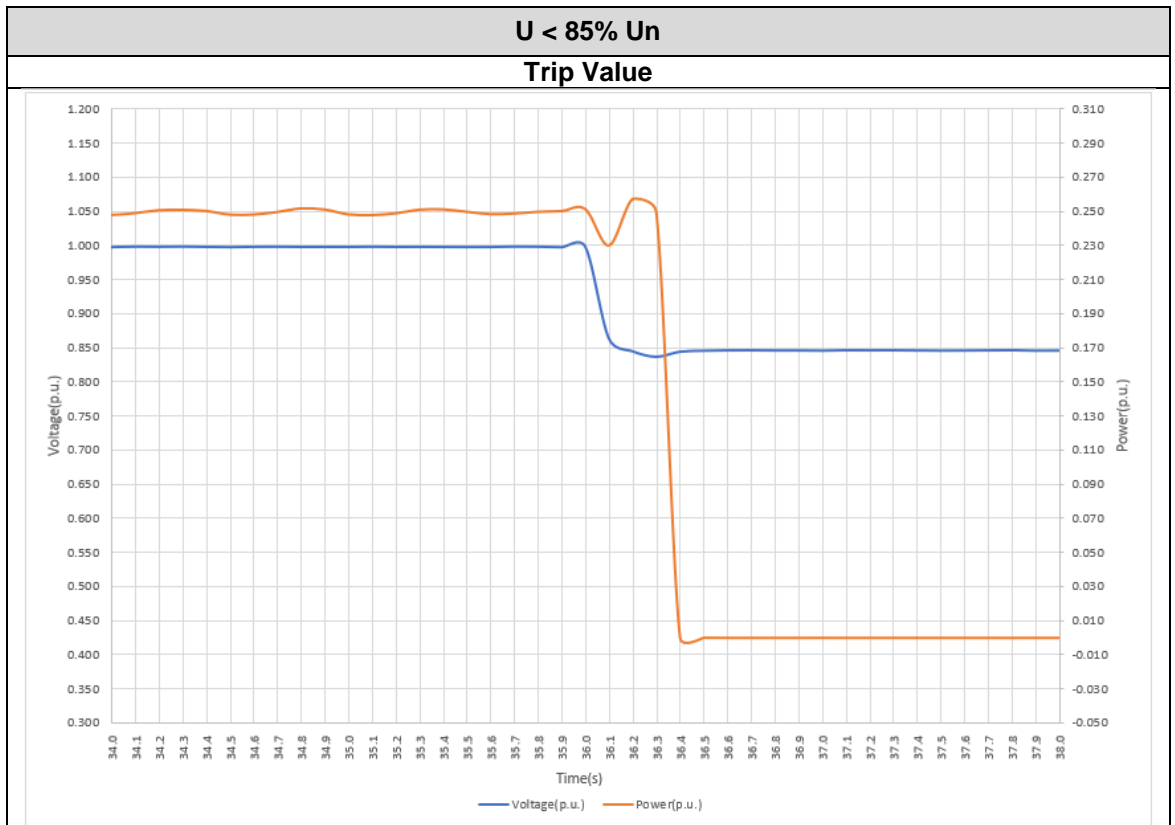

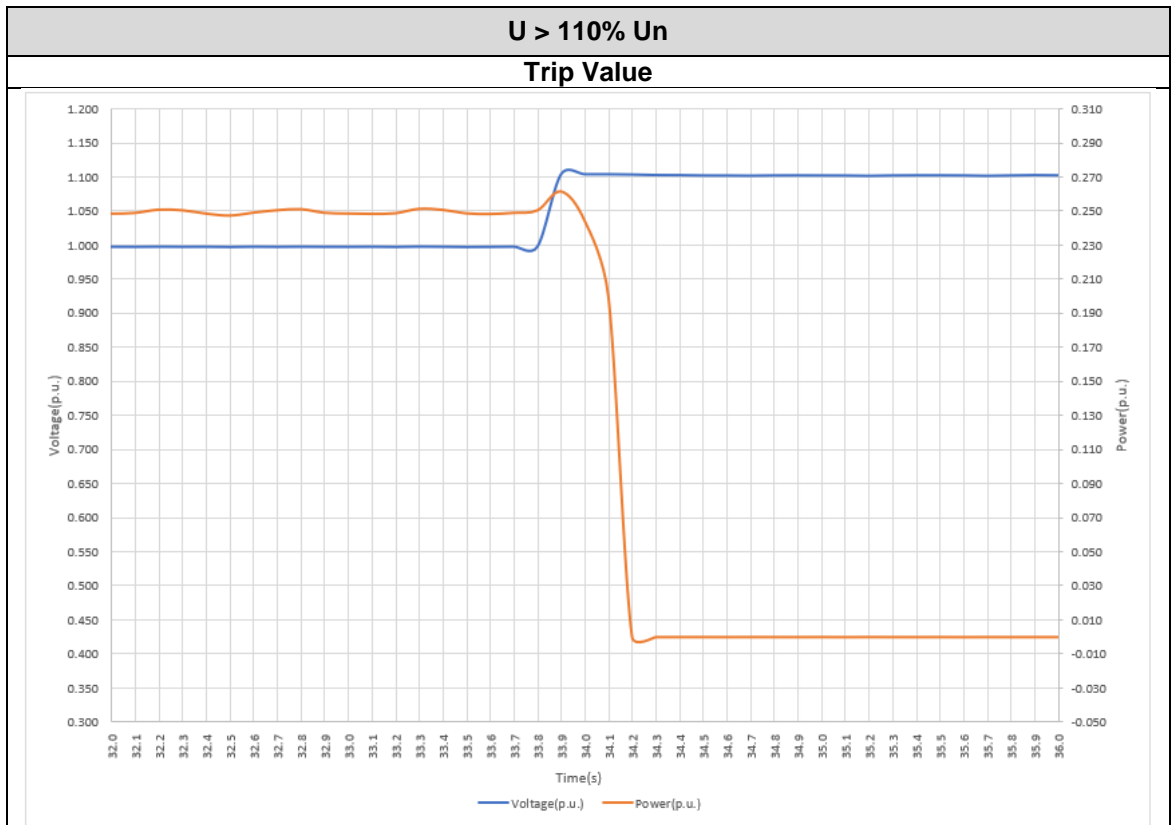

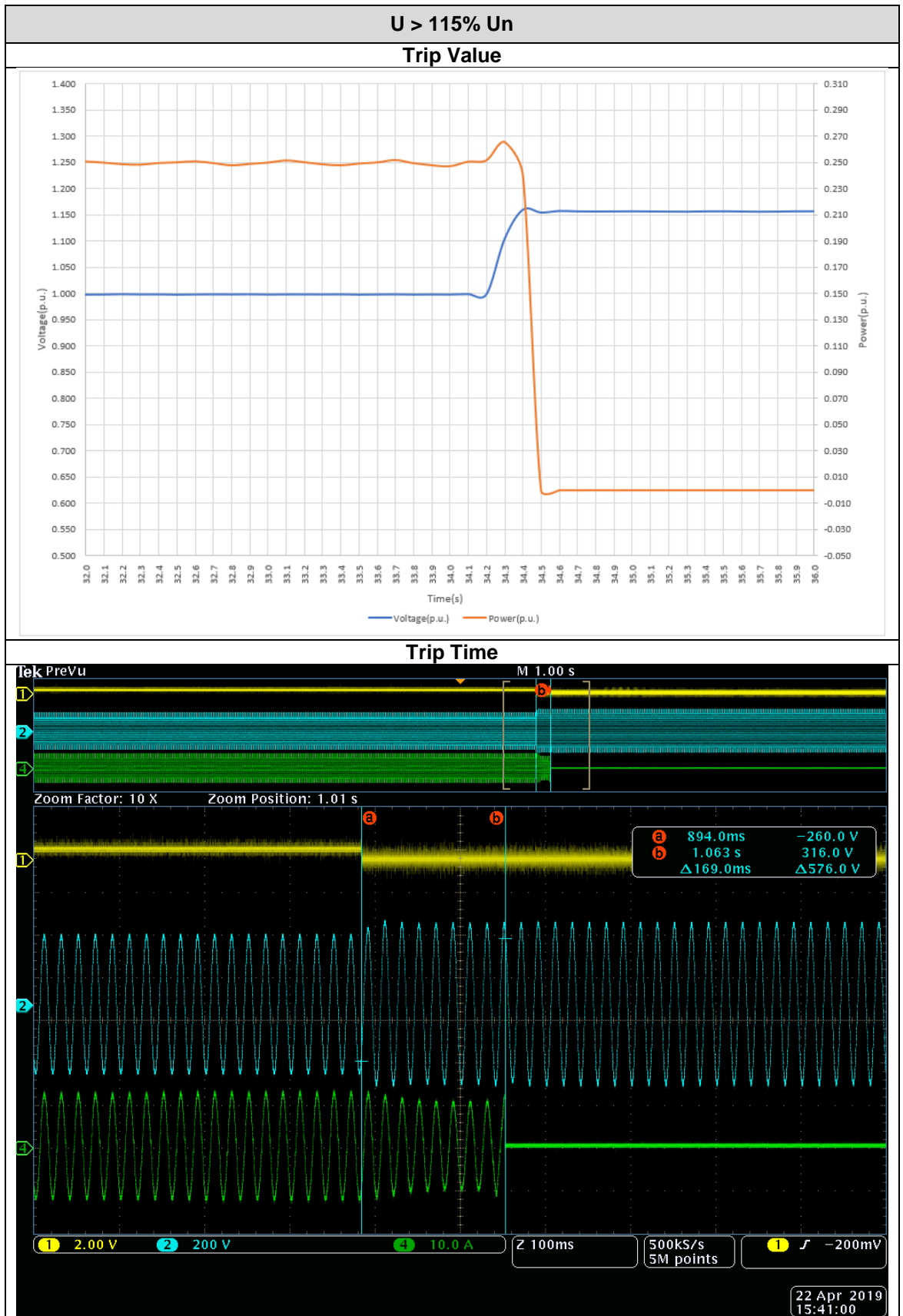

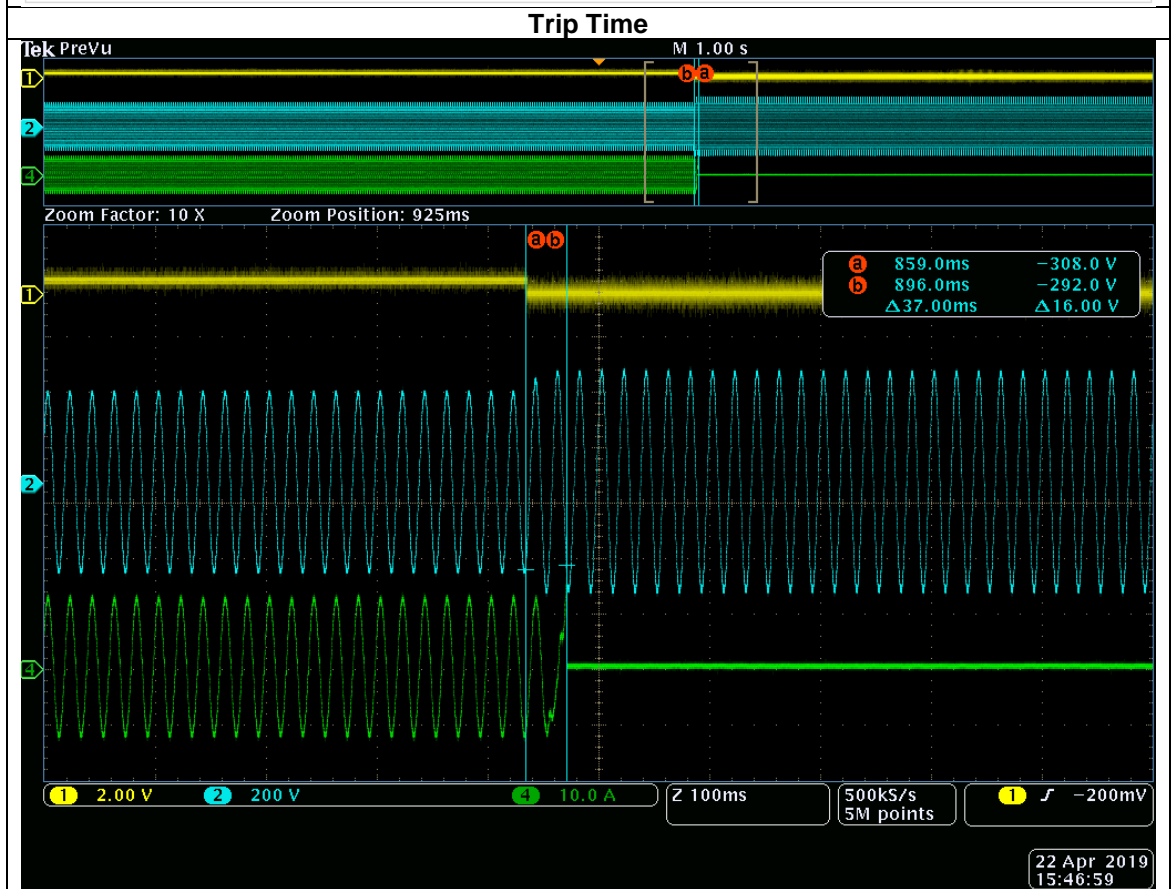
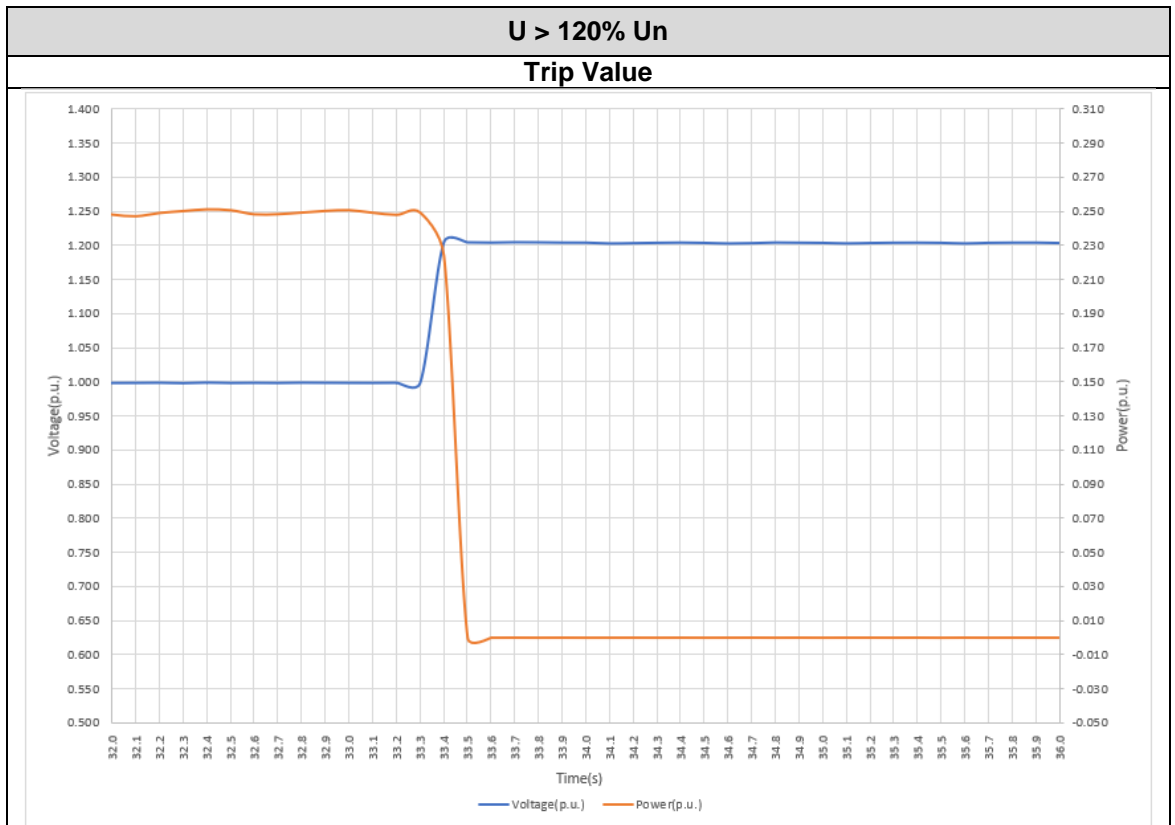

4.13.3 Overfrequency and underfrequency

Disconnection device have been considered according to Clause 4.2.2.3.3 of the standard

The random disconnect frequency shall be selected so that all generators from any specific manufacturer will disconnect uniformly over the range with 0.1 Hz increments

When the utility frequency is less than 47 Hz, the embedded generator shall disconnect from the utility network within 0.2 s.

When the utility frequency is more than 52 Hz for longer than 4 seconds, the embedded generator shall cease to energise the utility line within 0.5 s.

Power curtailment during over-frequency

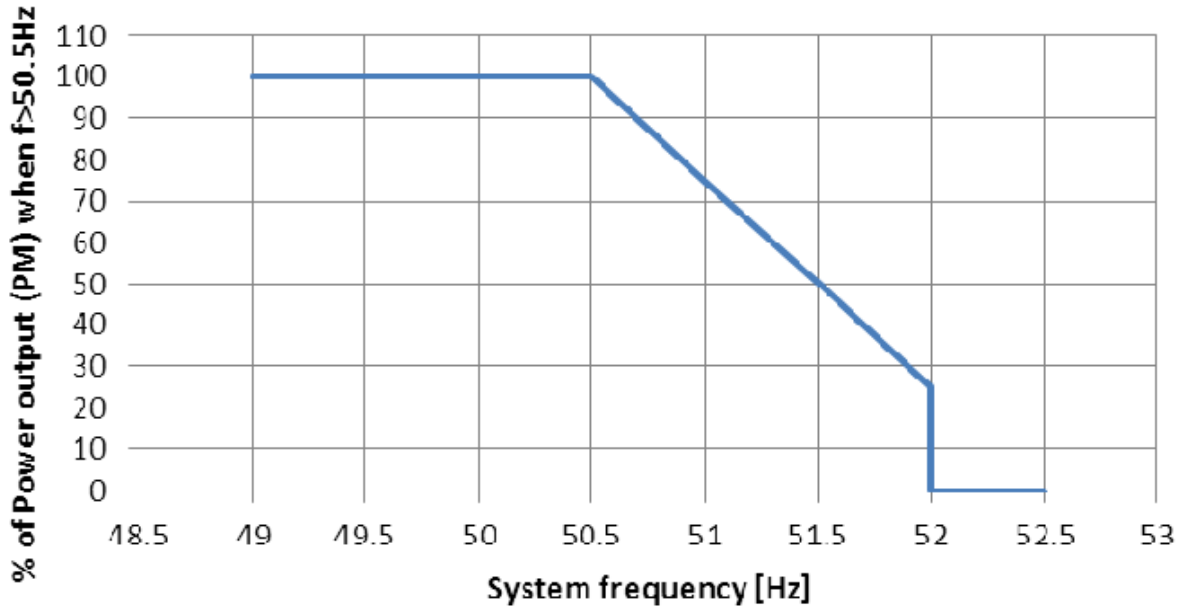

Frequency	Frequency Setting (Hz)	Frquency Trip (Hz)	Deviation (within ± 0.1 Hz)	Trip time limit (ms)	Time measured (ms)
f < 47Hz	47.000	46.903	-0.097	200	52
f > 52Hz	52.000	52.052	0.052	500	204

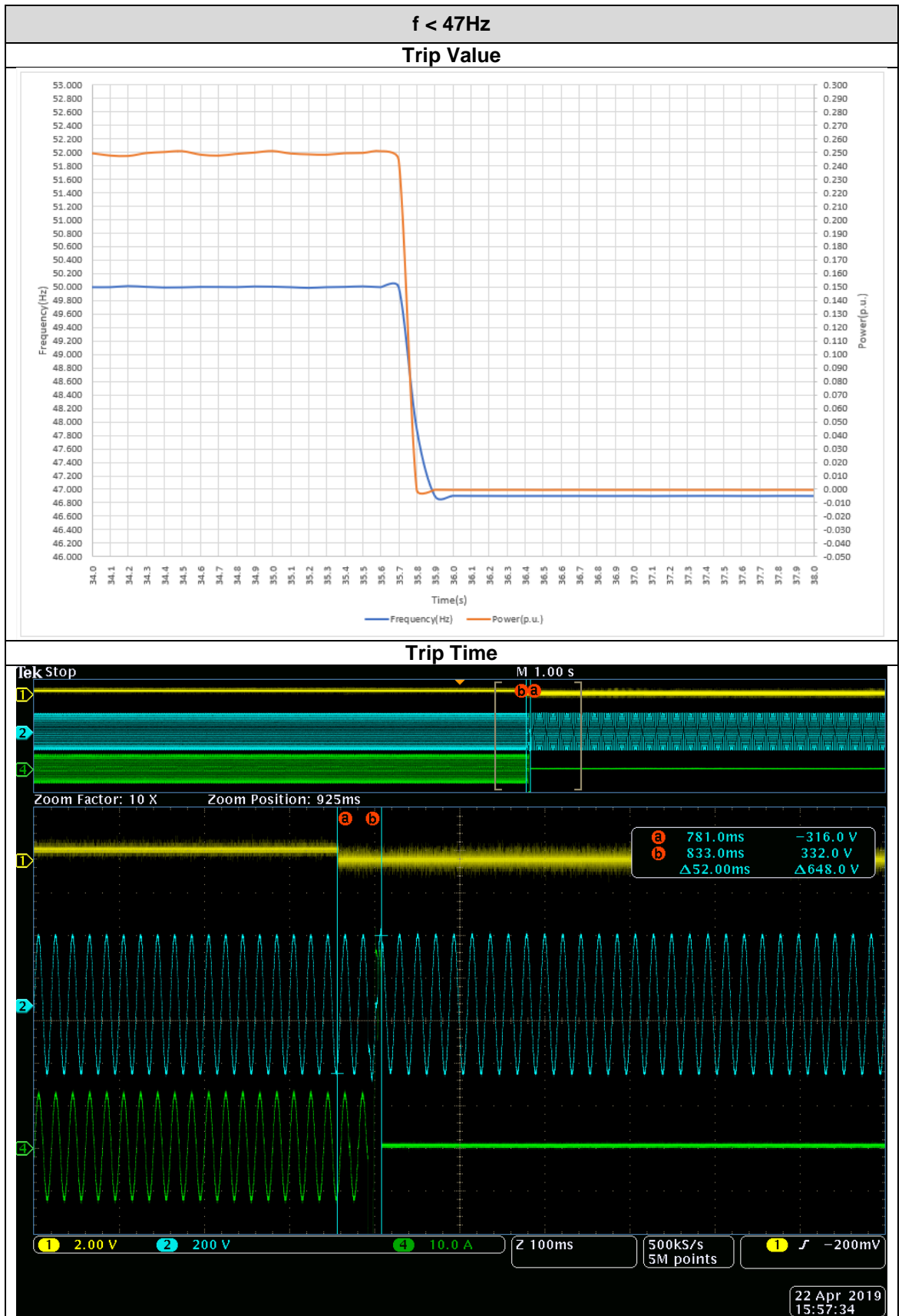

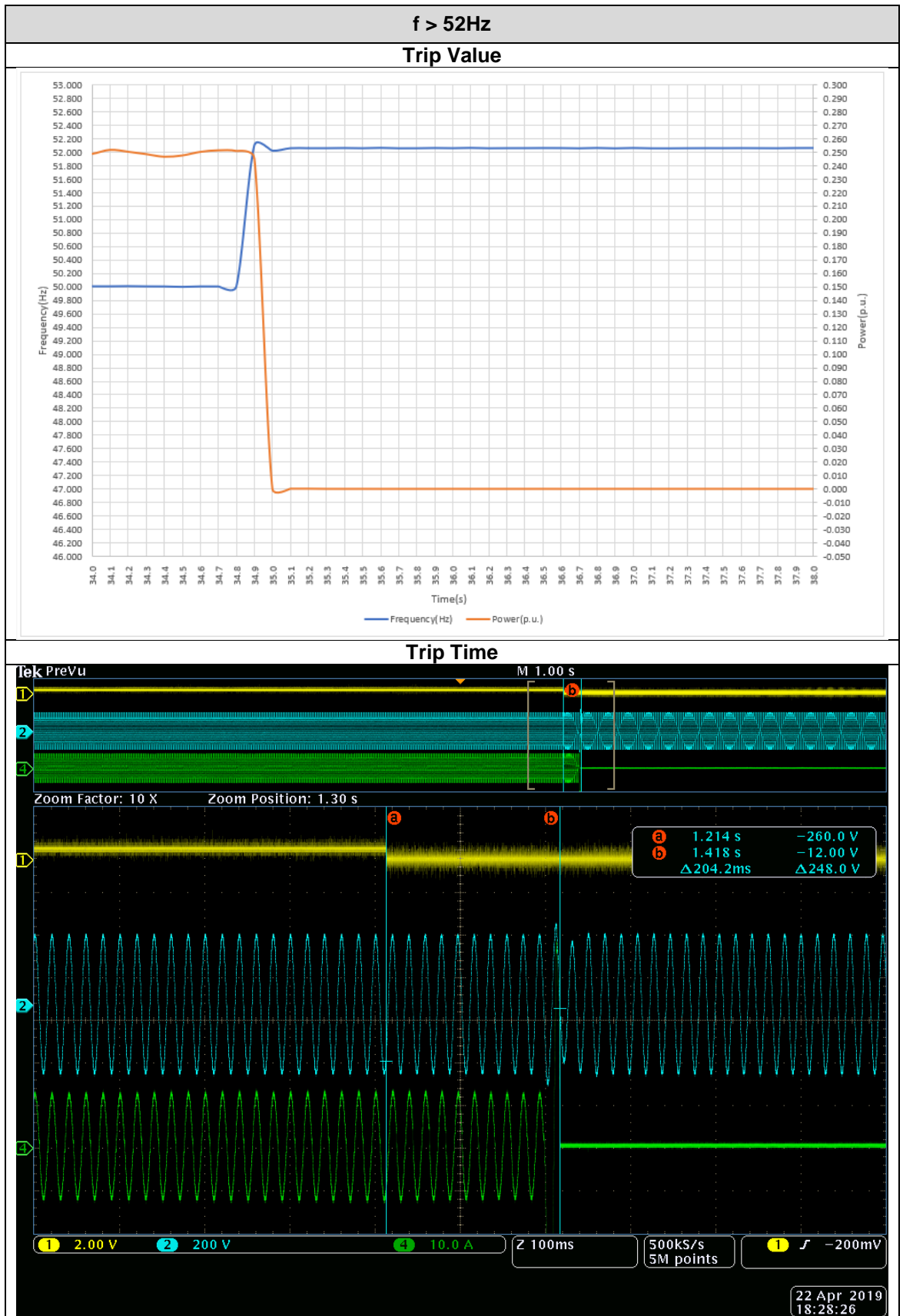

NRS 097-2-1: 2017 Edition 2

When the utility frequency exceeds 50.5 Hz, the active power available at the time shall be stored as the maximum power value P_M ; this value P_M shall not be exceeded until the frequency has stabilized below 50.5 Hz for at least 4 seconds

The EG system shall control the output power as a function of P_M at a gradient of 50 % per Hertz as illustrated in figure 5. The power generation shall follow the curve shown in figure 5 up and down while the system frequency is in the range 50.5 Hz to 52 Hz.

The following table shows the test results:

F (Hz)	P Desired (p.u.)	P Measured (p.u.)	ΔP (p.u.)
49.00	1.000	0.999	-0.001
49.50	1.000	0.999	-0.001
50.00	1.000	0.999	-0.001
50.50	1.000	0.999	-0.001
51.00	0.750	0.723	-0.027
51.90	0.300	0.275	-0.025
52.00	0.000	0.000	0.000

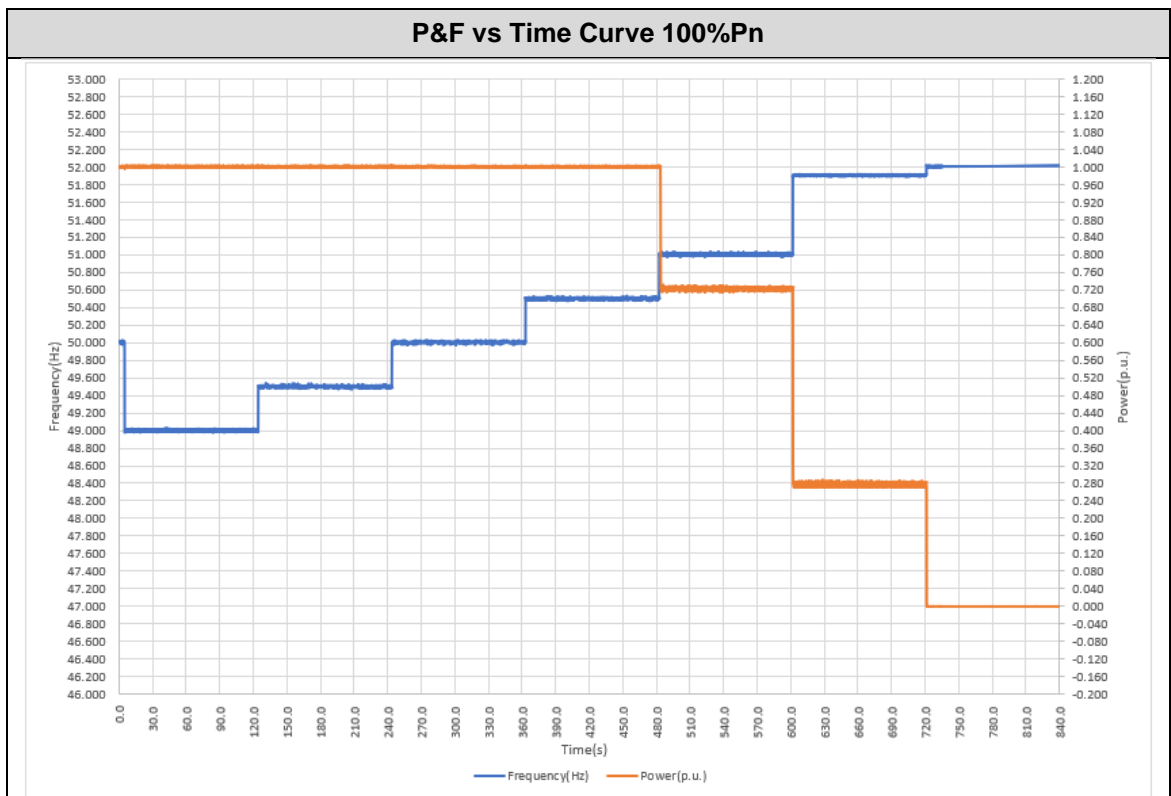

NRS 097-2-1: 2017 Edition 2

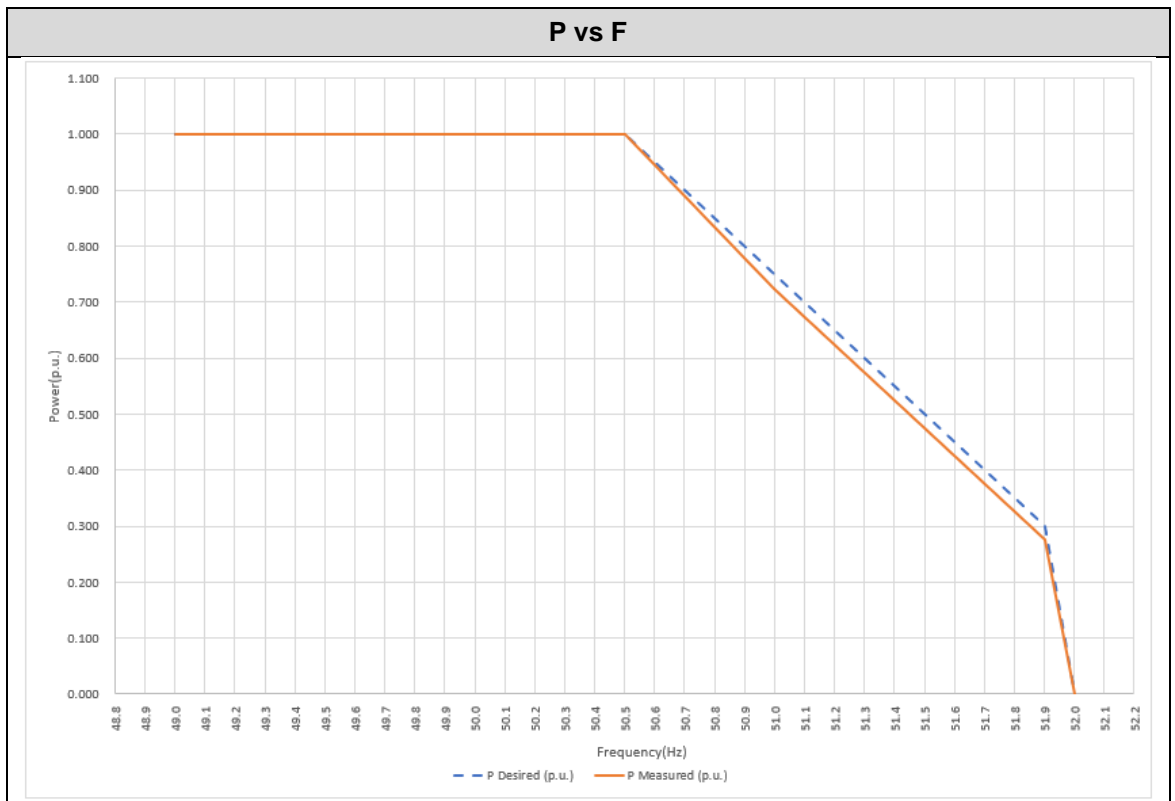

4.14 PREVENTION OF ISLANDING

Prevention of islanding tests have been measured according to Clause 4.2.2.4 of the standard.

An islanding condition shall cause the embedded generator to cease to energize the utility network within 2 s, irrespective of connected loads or other embedded generators.

Active islanding detection used for EUT. The test method according to IEC 62116: 2014

Table: tested condition and run-on time									
No.	P _{EUT} (% of EUT rating)	Reactive load (% of normal)	P _{AC}	Q _{AC}	Run-on time(ms)	P _{EUT} (kW)	Actual Q _f	V _{DC} (d.c.V)	Which load is selected to be adjusted (R or L)
Test Condition A									
1	100	100	0	0	1028	7359	0.98	425	--
2	100	100	-5	-5	1652	7371	0.99	425	R/L
3	100	100	-5	0	672	7367	1.02	425	R
4	100	100	-5	+5	528	7366	1.02	425	R/L
5	100	100	0	-5	1328	7356	1.04	425	L
6	100	100	0	+5	940	7361	0.99	425	L
7	100	100	+5	-5	1552	7371	0.96	425	R/L
8	100	100	+5	0	704	7370	0.98	425	R
9	100	100	+5	+5	736	7362	1.00	425	R/L
10	100	100	-10	+10	544	7356	1.01	425	R/L
11	100	100	-5	+10	572	7359	0.96	425	R/L
12	100	100	0	+10	624	7371	1.03	425	L
13	100	100	+10	+10	756	7371	1.05	425	R/L
14	100	100	+10	+5	1280	7364	1.01	425	R/L
15	100	100	+10	0	632	7355	0.99	425	R
16	100	100	+10	-5	1436	7356	0.99	425	R/L
17	100	100	+10	-10	480	7372	1.00	425	R/L
18	100	100	+5	-10	488	7369	1.04	425	R/L
19	100	100	0	-10	464	7362	1.04	425	L
20	100	100	-5	-10	360	7358	1.04	425	R/L
21	100	100	-10	-10	380	7353	1.03	425	R/L
22	100	100	-10	-5	1432	7369	0.99	425	R/L
23	100	100	-10	0	1044	7371	0.99	425	R
24	100	100	-10	+5	876	7362	0.99	425	R/L

NRS 097-2-1: 2017 Edition 2

Table: tested condition and run-on time									
No.	P _{EUT} (% of EUT rating)	Reactive load (% of normal)	P _{AC}	Q _{AC}	Run-on time(ms)	P _{EUT} (kW)	Actual Q _f	V _{DC} (d.c.V)	Which load is selected to be adjusted (R or L)
Test Condition B									
10	66	66	0	0	994	5250	1.02	290	--
11	66	66	0	-5	826	5252	1.03	290	L
12	66	66	0	-4	882	5251	1.03	290	L
13	66	66	0	-3	812	5251	0.98	290	L
14	66	66	0	-2	888	5240	0.99	290	L
15	66	66	0	-1	966	5253	0.98	290	L
16	66	66	0	1	566	5250	0.97	290	L
17	66	66	0	2	680	5251	1.01	290	L
18	66	66	0	3	536	5254	1.04	290	L
19	66	66	0	4	798	5248	1.04	290	L
20	66	66	0	5	790	5251	1.04	290	L
Test Condition C									
21	33	33	0	0	992	2635	1.01	190	--
22	33	33	0	-5	648	2626	1.01	190	L
23	33	33	0	-4	688	2624	1.01	190	L
24	33	33	0	-3	628	2635	1.01	190	L
25	33	33	0	-2	546	2630	0.99	190	L
26	33	33	0	-1	524	2635	0.97	190	L
27	33	33	0	1	760	2632	0.97	190	L
28	33	33	0	2	664	2628	1.04	190	L
29	33	33	0	3	594	2632	1.04	190	L
30	33	33	0	4	442	2629	1.02	190	L
31	33	33	0	5	422	2630	1.00	190	L
Remark: For test condition A: If any of the recorded run-on times are longer than the one recorded for the rated balance condition, then the non-shaded parameter combinations also require testing. For test condition B and C: If run-on times are still increasing at the 95 % or 105 % points, additional 1 % increments is taken until run-on times begin decreasing.									

4.15 ISOLATION

The embedded generator shall provide circuit break between EG and grid to isolating from the utility interface in order to allow for safe maintenance of the EG. The disconnection device is a double pole for a single-phase EG.

4.16 EARTHING

Installations with utility-interconnected inverters without simple separation shall make use of earth leakage protection which are able to respond to d.c. fault currents including smooth d.c. fault currents (i.e. without zero crossings) according to IEC 62109-2.

4.17 LABELLING

A label on the distribution board of the premises where the embedded generator is connected shown in figure 6, shall state: "WARNING: ON-SITE EMBEDDED GENERATION . DO NOT WORK ON THIS EQUIPMENT UNTIL IT IS ISOLATED FROM BOTH MAINS AND ON-SITE GENERATION SUPPLIES." as following. Disconnection points for all supplies shall be indicated in use manual.

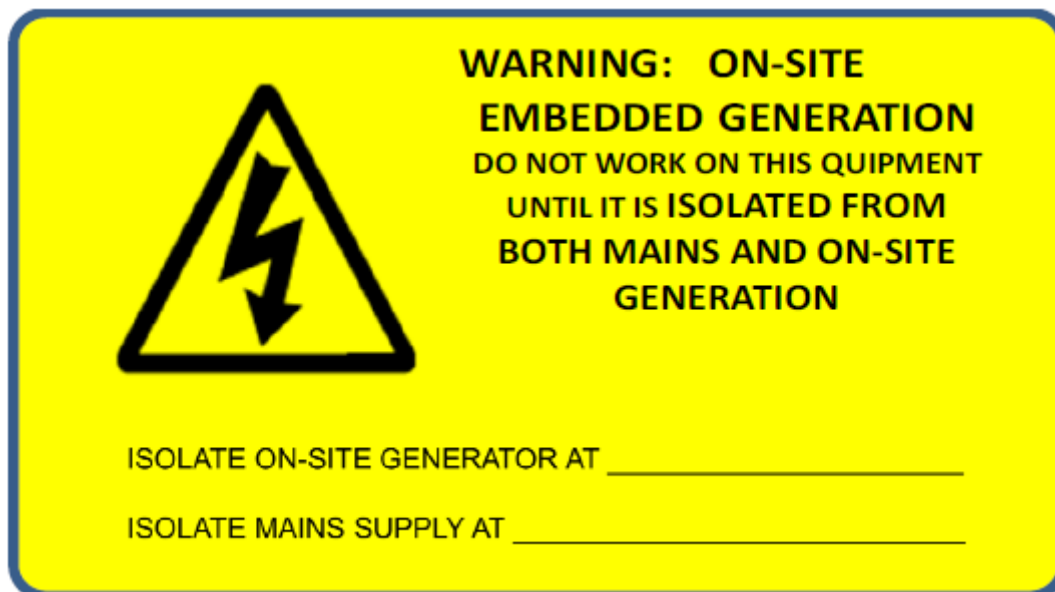

Note: The label shall be permanent with lettering of height at least 8 mm.

4.18 ROBUSTNESS REQUIREMENTS

Robustness requirement have been considered according to Clause 4.2.10 of the standard.

The safety requirements in accordance with IEC 62109-1:2010 and IEC 62109-2:2011.

The compliances with these requirements are stated in the following test report:

- Test report n° SHES190301262471, SHES190301262472 on 28/03/2019

5 PICTURES

Front



Top side

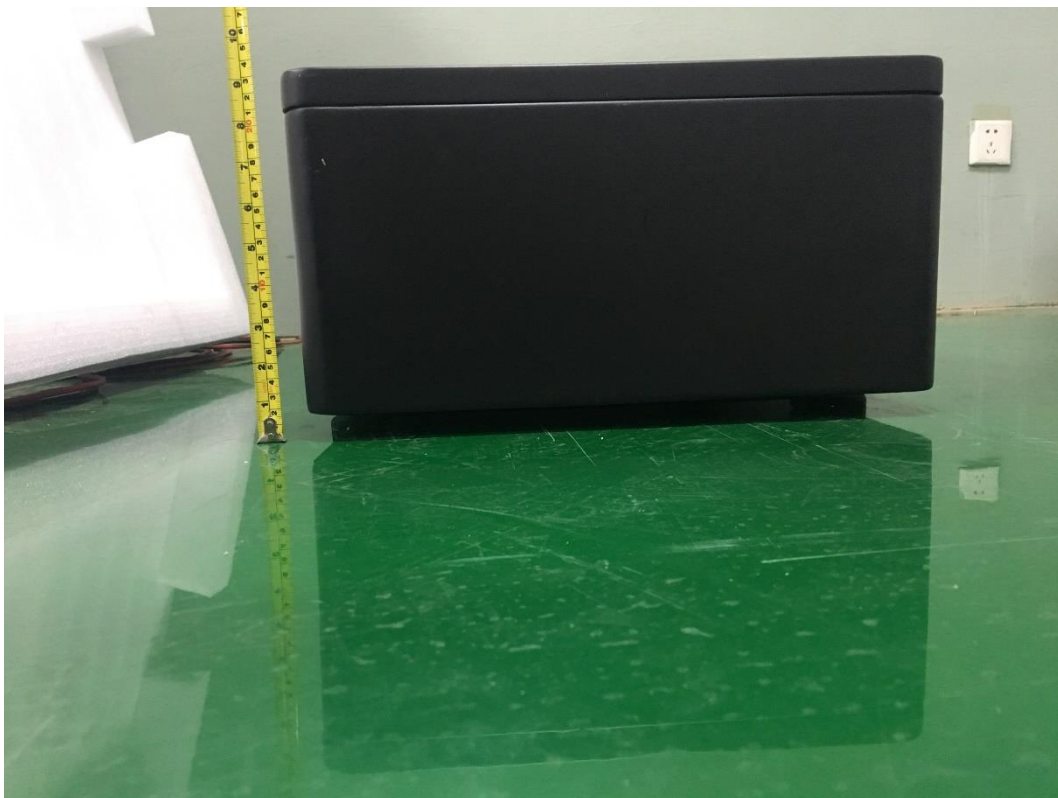

Left Side



Right Side



Internal view



Front view of Control Board

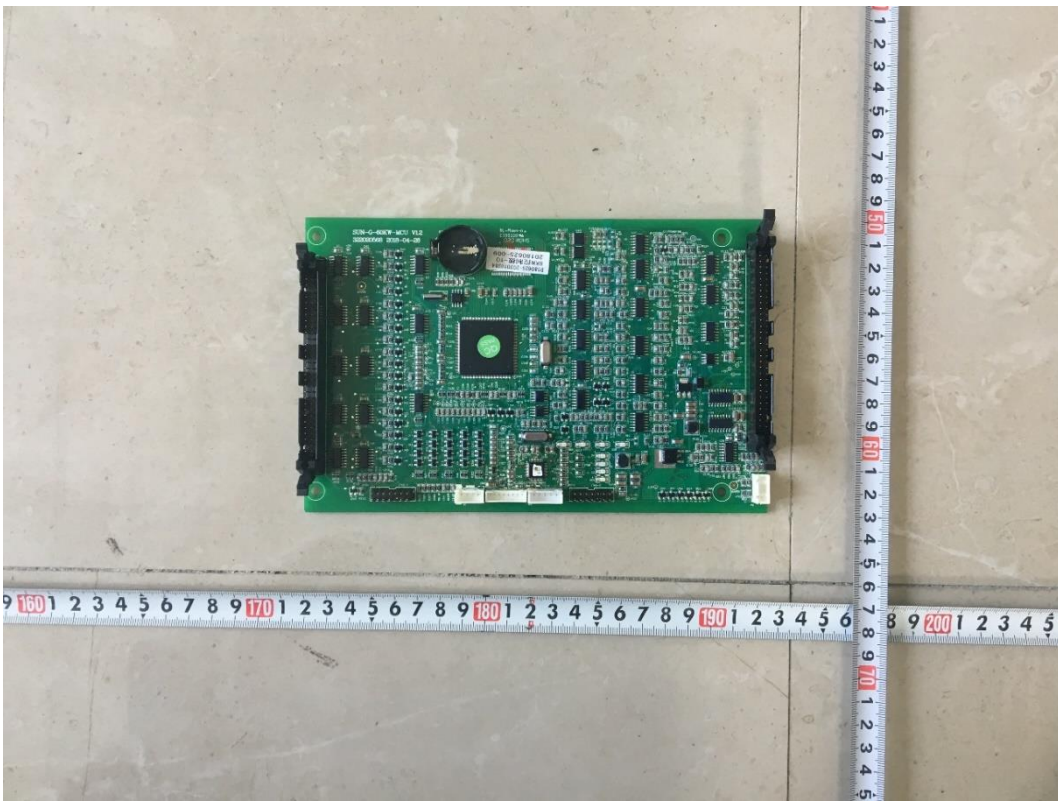

Back view of Control Board

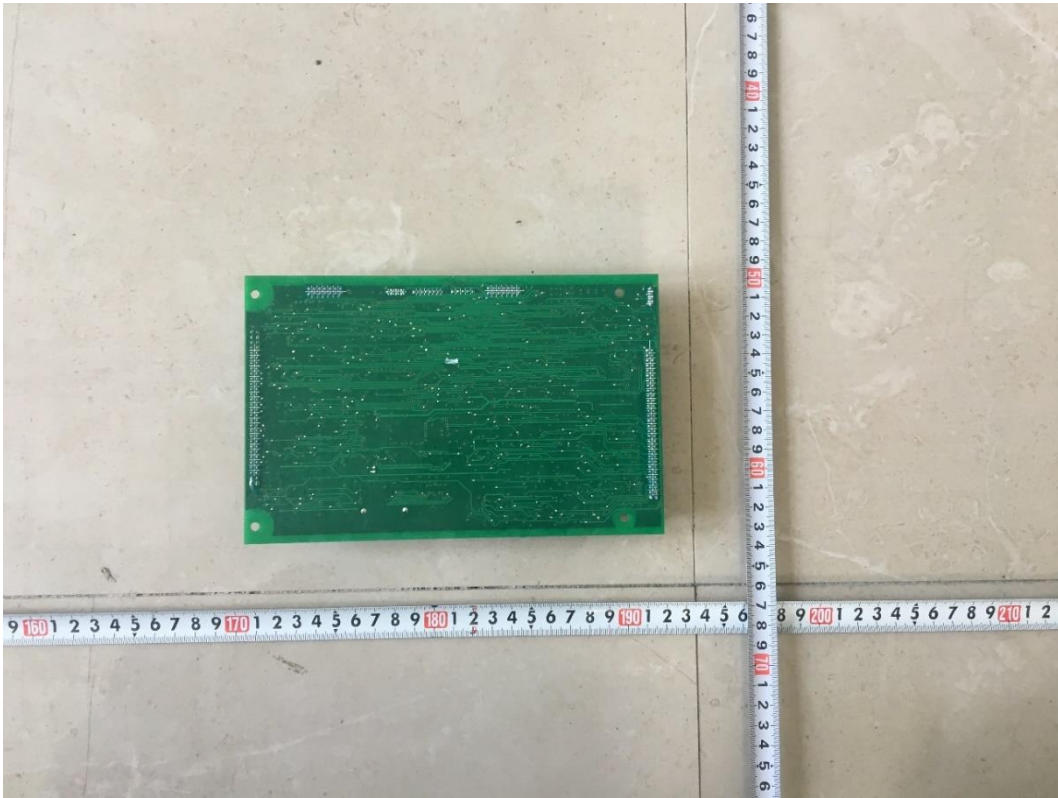

Front view of ARC Board

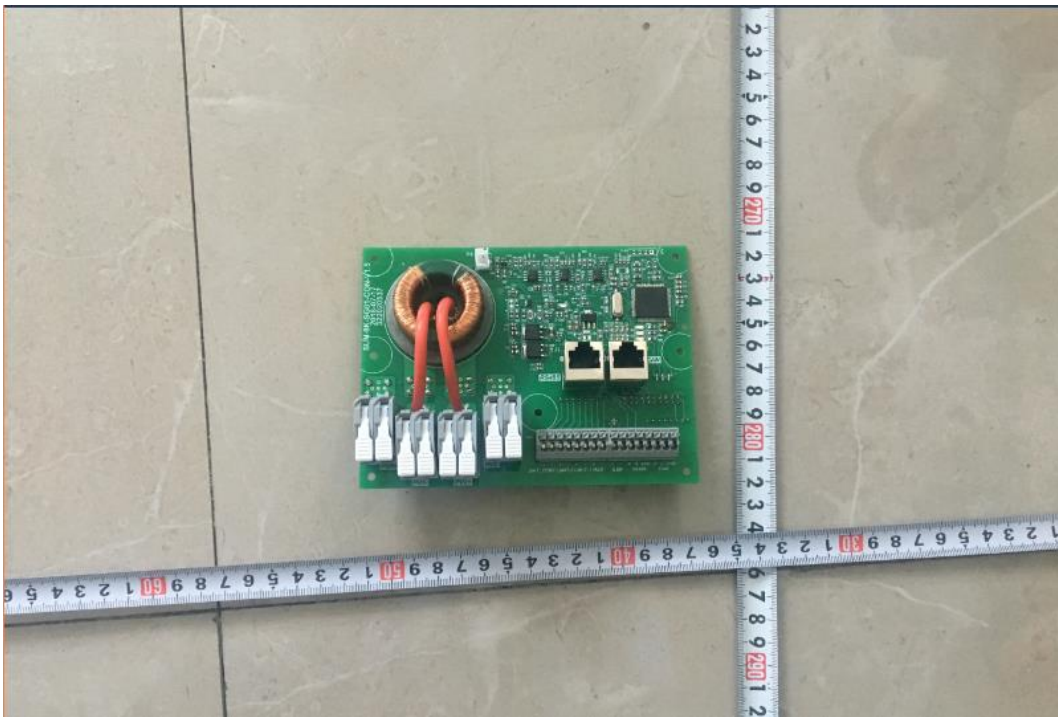

Back view of ARC Board

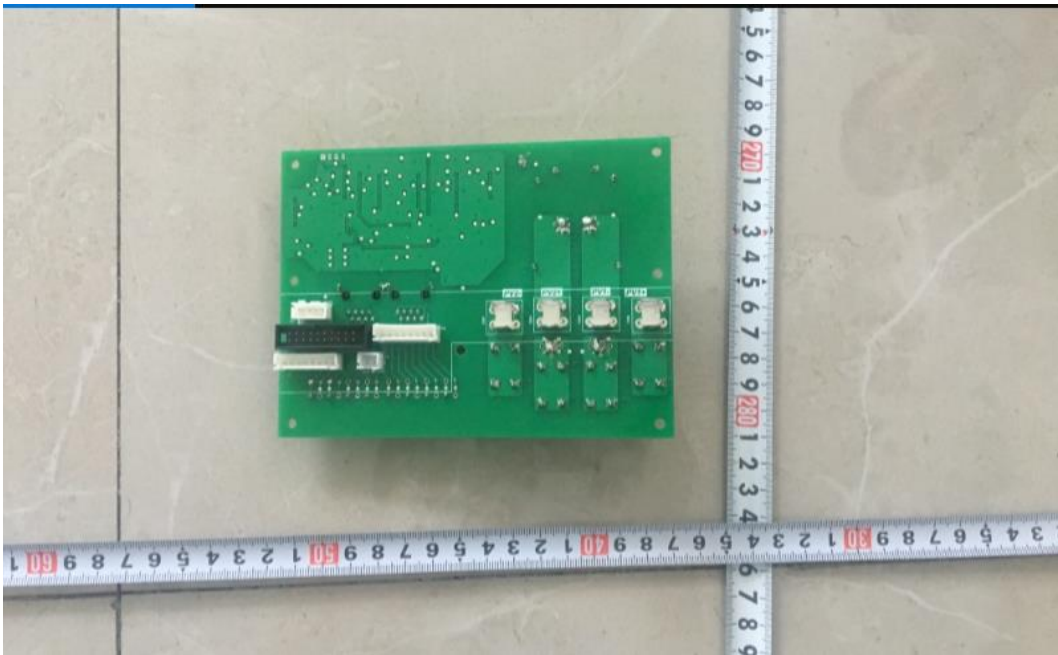

Front view of Driving Board

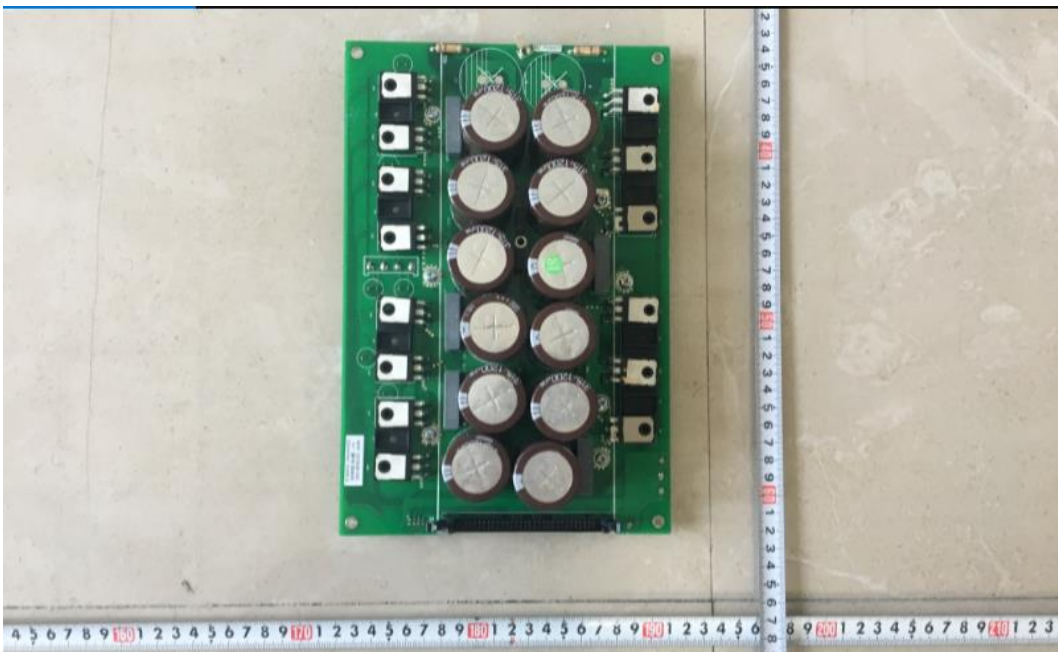

Back view of Driving Board

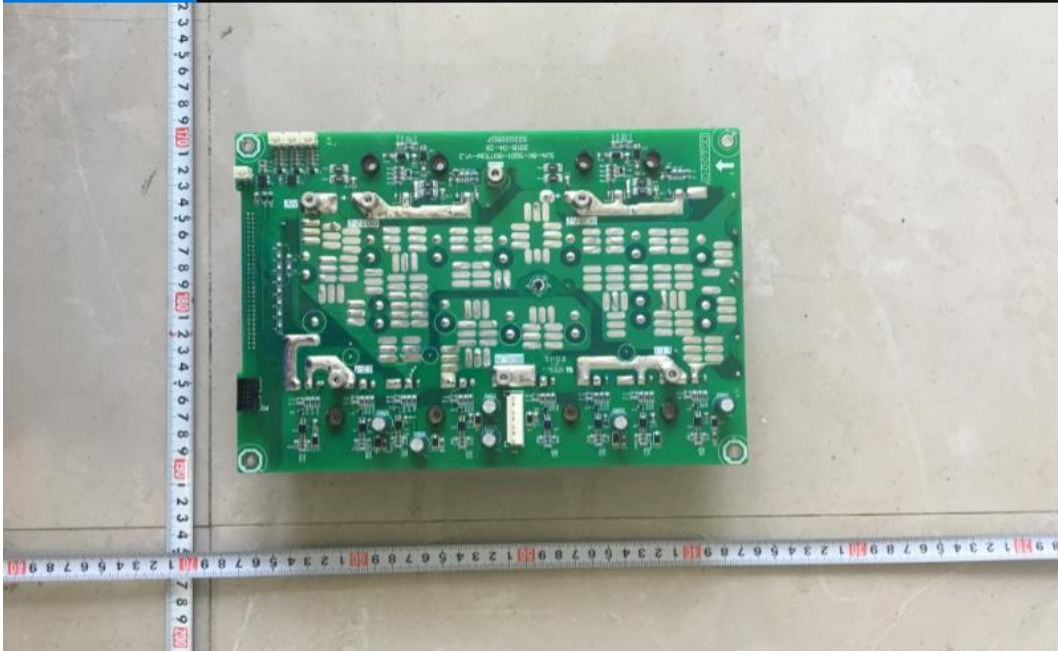

Front view of BOOST Board

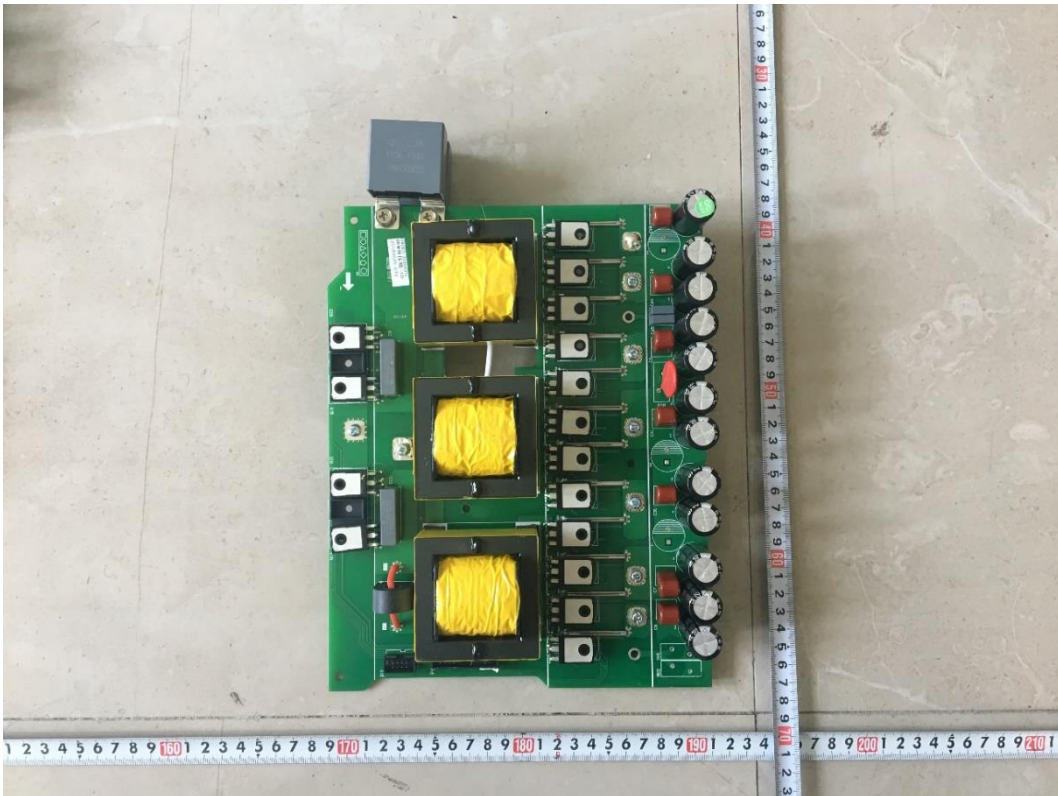

Back view of BOOST Board

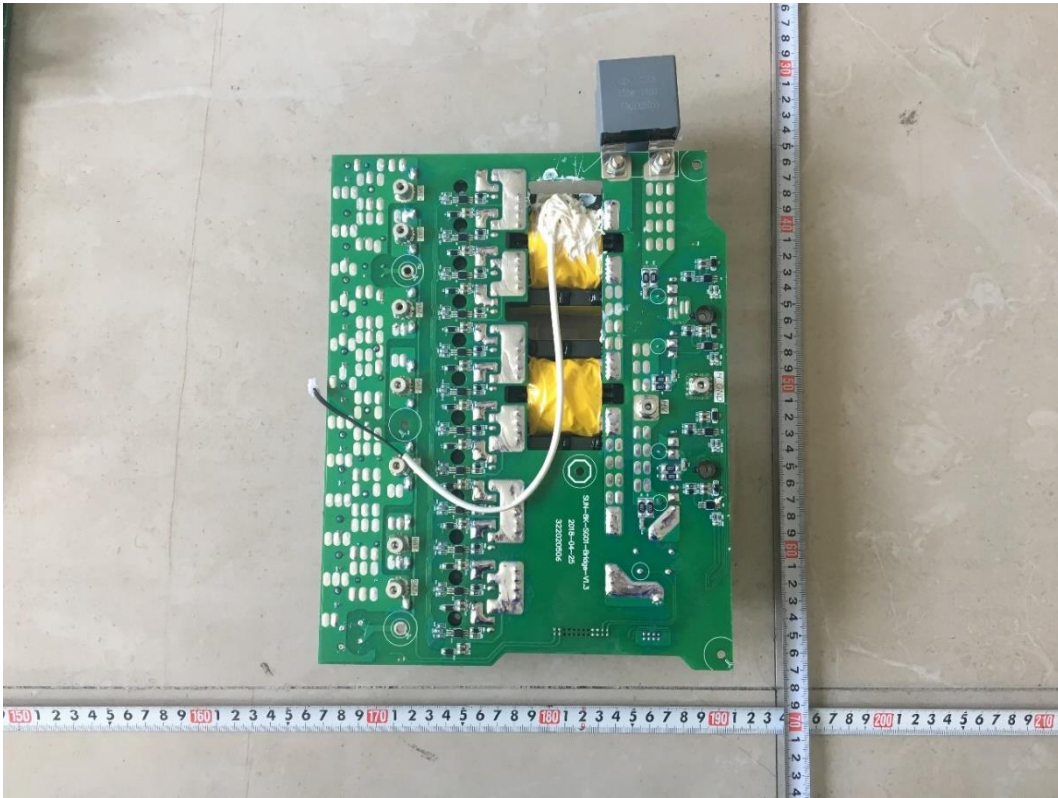

Front view of Display Board

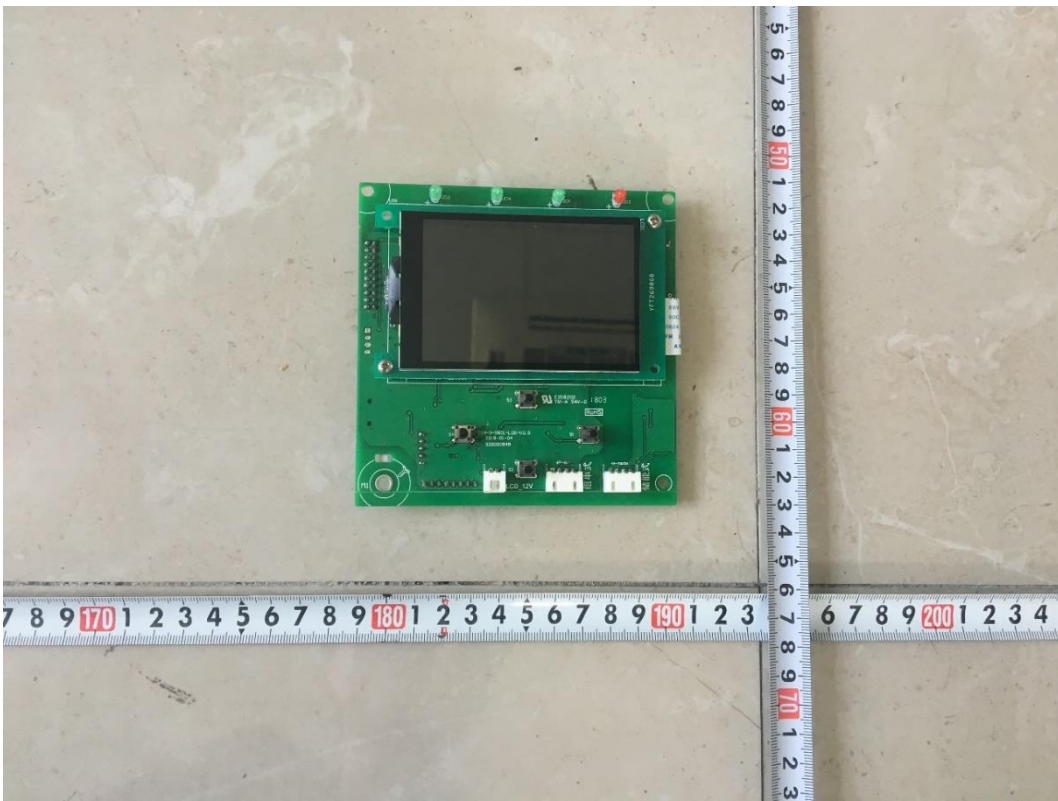

Back view of Display Board

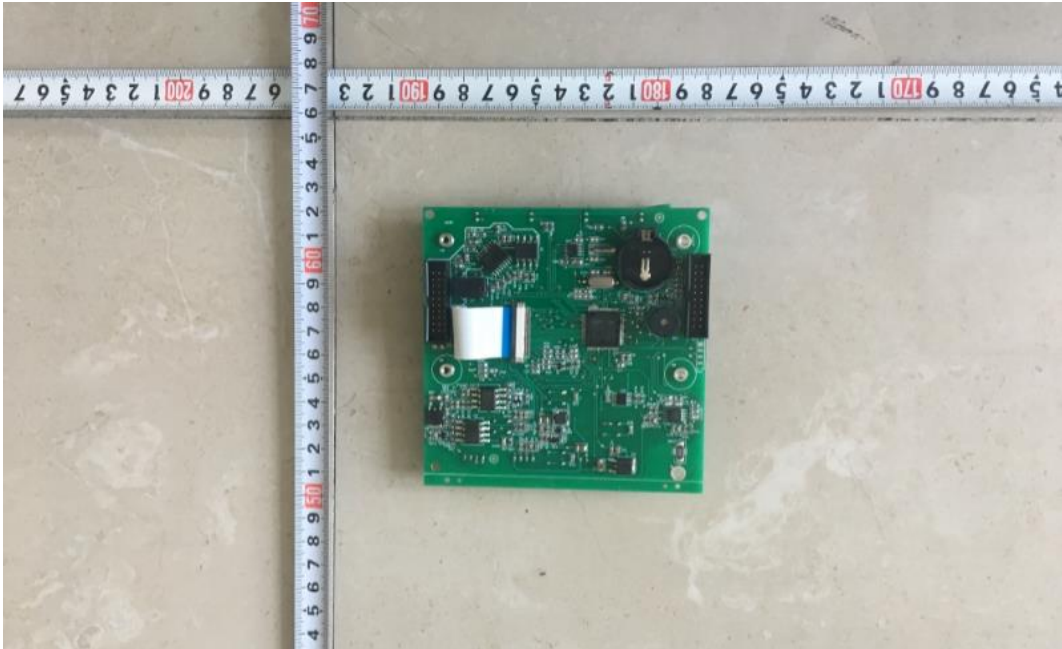

Front view of Main Board

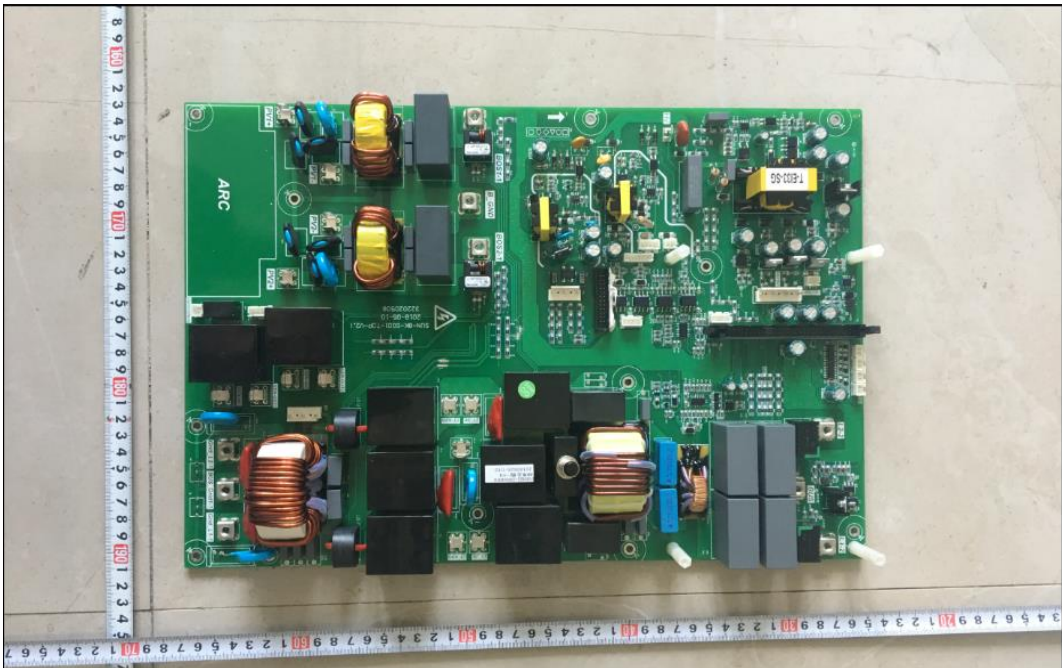

Back view of Main Board

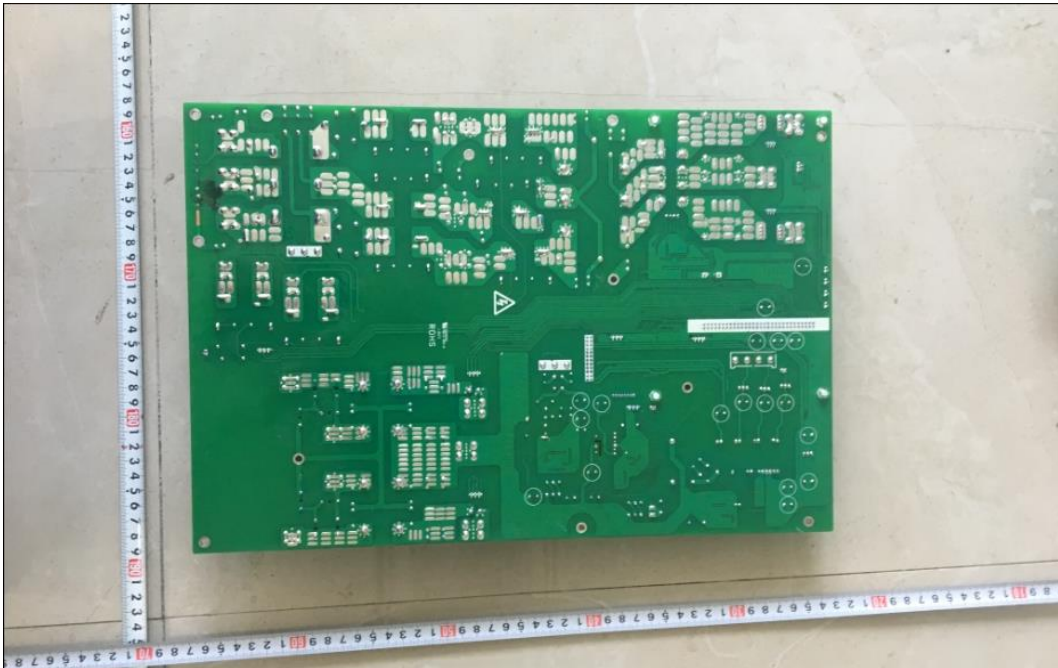

Serial Number and Software Version

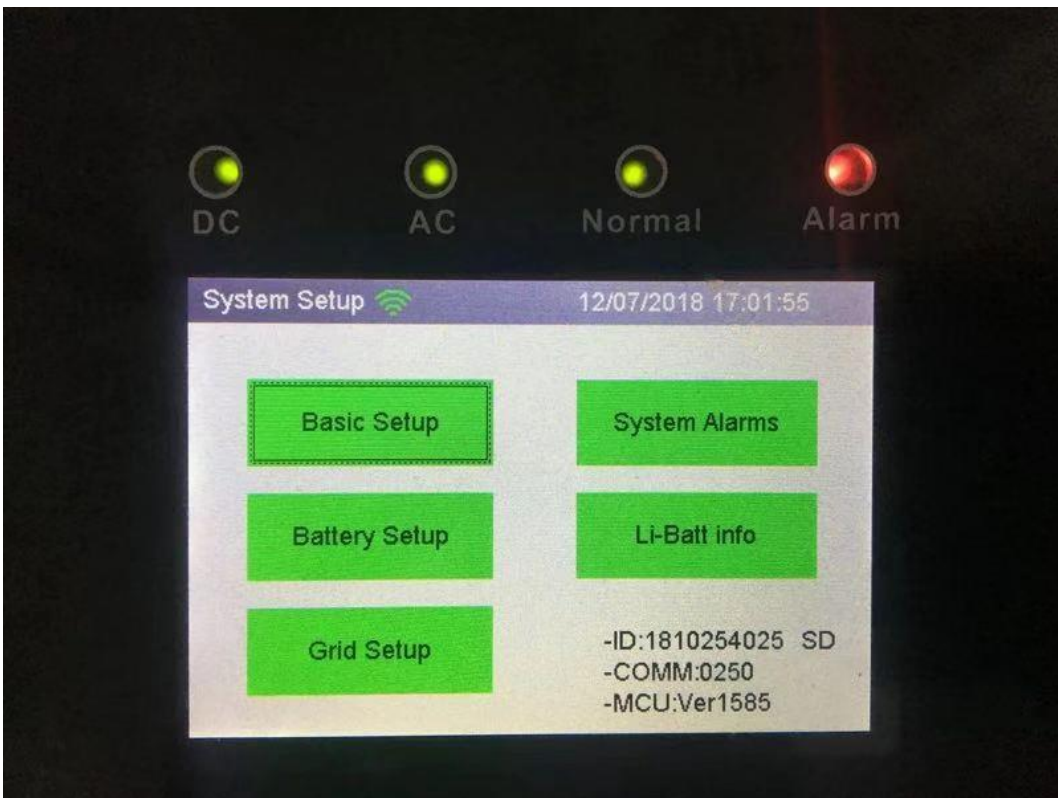

6 ELECTRICAL SCHEMES

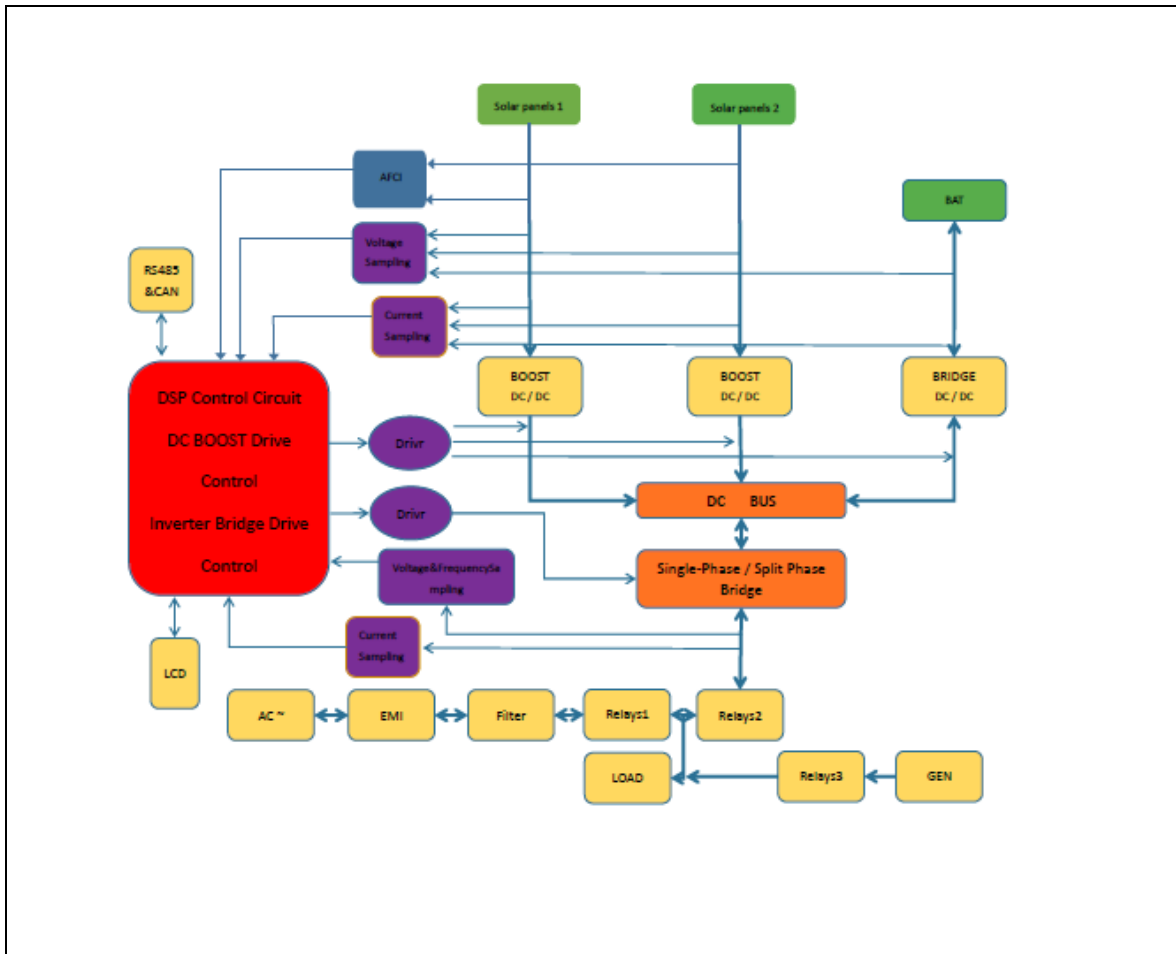

-----END OF REPORT-----